



ZUBIOLA

DIAMOND TOOLS SOLUTIONS

AUTOMOTIVE AERONAUTICS INDUSTRY

PRODUCT CATALOGUE

countersinks

drill bits

reamers

cutters

inserts & cartridges

Il sistema di riferimento è costituito da:

Il sistema di riferimento è costituito da:

Il sistema di riferimento è costituito da:

Il sistema di riferimento è costituito da:

Il sistema di riferimento è costituito da:



ZUBIOLA

DIAMOND TOOLS SOLUTIONS

AUTOMOTIVE AERONAUTICS INDUSTRY

PRODUCT CATALOGUE

countersinks

drill bits

reamers

cutters

inserts & cartridges

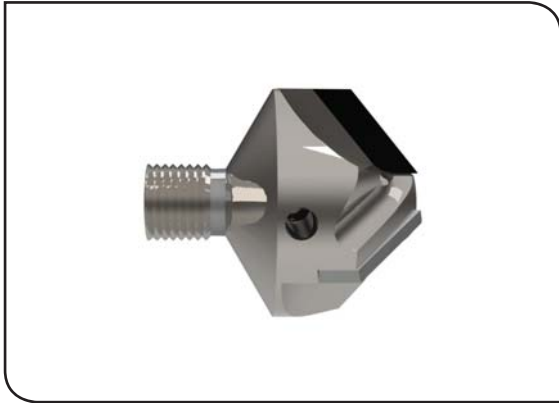

PARA MECANIZADO DE FIBRA DE CARBONO



A1001

D	d1	d	Z	LT	CÓDIGO	€
10	2	M6x1	2	28.5	610011002000	
10	2.5	M6x1	2	28.5	610011002500	
12	3	M6x1	2	28.5	610011203000	
14	4	M8x1	2	28.5	610011404000	
22	5	M8x1	3	28.5	610012205000	
28	6	M10x1	3	38.5	610012806000	

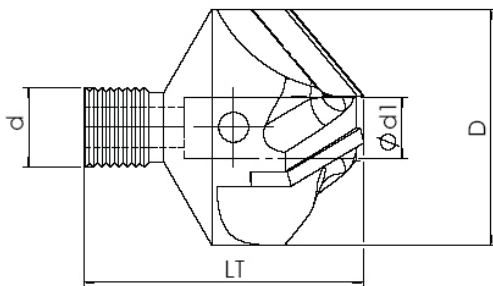



Avellanadores con placas de diamante policristalino para el mecanizado de Fibra de carbono.



A100P

D	d1	d	R	LT	Z	CÓDIGO
12	4.82	M6x1	0.6	37	2	610001204820
14	6.34	M8x1	0.6	38	2	610001406340
17	7.93	M8x1	0.9	39	2	610001707930
17	9.51	M8x1	0.9	40	2	610001709510
14	5.54	M8x1	0.6	38	3	610001405540
14	5.94	M8x1	0.6	38	3	610001405940
14	6.34	M8x1	0.6	40	3	610001406340
14	6.74	M8x1	0.6	40	3	610001406740
14	7.13	M8x1	0.6	41	3	610001407130
17	7.93	M8x1	0.9	43	3	610001707930
17	8.32	M8x1	0.9	43	3	610001708320
17	8.72	M8x1	0.9	44	3	610001708720
17	9.51	M8x1	0.9	46	3	610001709510
21	11.1	M10x1	1.3	41	3	610002101110
21	11.1	M8x1	1.3	48	3	610002101111
26	12.69	M10x1	1.2	65	3	610002601269
26	14.27	M10x1	1.2	68	3	610002601427
32	15.85	M10x1	1.2	71	3	610003211585

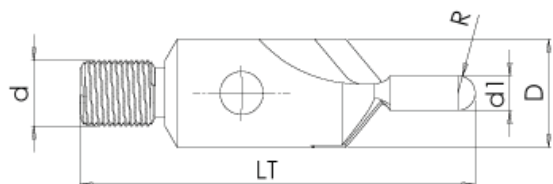



PARA EL MECANIZADO DE FIBRA DE CARBONO



A100PC

D	d1	d	R	LT	Z	CÓDIGO	€
12	4.82	M6x1	0.6	37	2	610011204820	
14	6.34	M8x1	0.6	38	2	610011406340	
17	7.93	M8x1	0.9	39	2	610011707930	
17	9.51	M8x1	0.9	40	2	610011709510	
14	5.54	M8x1	0.6	38	3	610011405540	
14	5.94	M8x1	0.6	38	3	610011405940	
14	6.34	M8x1	0.6	40	3	610011406340	
14	6.74	M8x1	0.6	40	3	610011406740	
14	7.13	M8x1	0.6	41	3	610011407130	
17	7.93	M8x1	0.9	43	3	610011707930	
17	8.32	M8x1	0.9	43	3	610011708320	
17	8.72	M8x1	0.9	44	3	610011708720	
17	9.51	M8x1	0.9	46	3	610011709510	
21	11.1		1.3	41	3	610012101110	
21	11.1		1.3	48	3	610012101111	
26			1.2	65	3	610012601269	
26			1.2	68	3	610012601427	
32			1.2	71	3	610013211585	

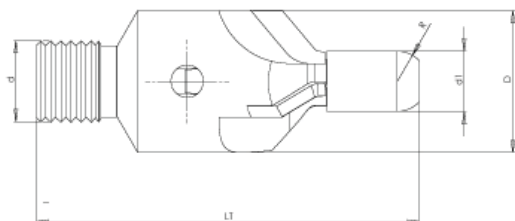



PARA EL MECANIZADO DE FIBRA DE CARBONO

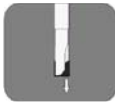
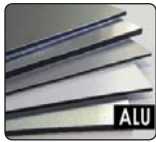
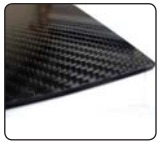

A130I

D	d1	d	Z	LT	CÓDIGO	€
10	2	M6x1	2	28.5	613011003000	
10	2.5	M6x1	2	28.5	613011003500	
10	2.5	M6x1	2	28.5	613011004000	
14	4	M8x1	2	28.5	613014004800	
14	4	M8x1	2	28.5	613014005000	
14	4	M8x1	2	28.5	613014006000	

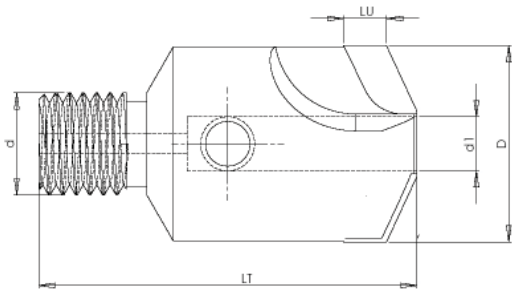

Il presente documento è riservato ai soli destinatari autorizzati. È vietata espressamente la ristampa o l'uso non autorizzato senza permesso scritto dalla Direzione Generale.

Il presente documento è riservato ai soli destinatari autorizzati. È vietata espressamente la ristampa o l'uso non autorizzato senza permesso scritto dalla Direzione Generale.

Il presente documento è riservato ai soli destinatari autorizzati. È vietata espressamente la ristampa o l'uso non autorizzato senza permesso scritto dalla Direzione Generale.

Il presente documento è riservato ai soli destinatari autorizzati. È vietata espressamente la ristampa o l'uso non autorizzato senza permesso scritto dalla Direzione Generale.

Il presente documento è riservato ai soli destinatari autorizzati. È vietata espressamente la ristampa o l'uso non autorizzato senza permesso scritto dalla Direzione Generale.



ZUBIOLA

DIAMOND TOOLS SOLUTIONS

AUTOMOTIVE AERONAUTICS INDUSTRY

PRODUCT CATALOGUE

countersinks

drill bits

reamers

cutters

inserts & cartridges



BROCA PARA TALADRADO DE ALUMINIO Y FIBRAS

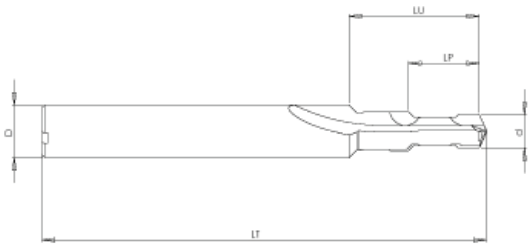
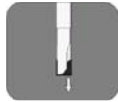
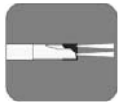
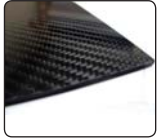

Il presente documento è riservato ai soli destinatari autorizzati. È vietata espressamente la ristampa o l'uso non autorizzato senza permesso scritto dalla Direzione Generale.

Il presente documento è riservato ai soli destinatari autorizzati. È vietata espressamente la ristampa o l'uso non autorizzato senza permesso scritto dalla Direzione Generale.

Il presente documento è riservato ai soli destinatari autorizzati. È vietata espressamente la ristampa o l'uso non autorizzato senza permesso scritto dalla Direzione Generale.

Il presente documento è riservato ai soli destinatari autorizzati. È vietata espressamente la ristampa o l'uso non autorizzato senza permesso scritto dalla Direzione Generale.

Il presente documento è riservato ai soli destinatari autorizzati. È vietata espressamente la ristampa o l'uso non autorizzato senza permesso scritto dalla Direzione Generale.

Il presente documento è riservato ai soli destinatari autorizzati. È vietata espressamente la ristampa o l'uso non autorizzato senza permesso scritto dalla Direzione Generale.

Il presente documento è riservato ai soli destinatari autorizzati. È vietata espressamente la ristampa o l'uso non autorizzato senza permesso scritto dalla Direzione Generale.

Il presente documento è riservato ai soli destinatari autorizzati. È vietata espressamente la ristampa o l'uso non autorizzato senza permesso scritto dalla Direzione Generale.

Il presente documento è riservato ai soli destinatari autorizzati. È vietata espressamente la ristampa o l'uso non autorizzato senza permesso scritto dalla Direzione Generale.

Il presente documento è riservato ai soli destinatari autorizzati. È vietata espressamente la ristampa o l'uso non autorizzato senza permesso scritto dalla Direzione Generale.



ZUBIOLA

DIAMOND TOOLS SOLUTIONS

AUTOMOTIVE AERONAUTICS INDUSTRY

PRODUCT CATALOGUE

countersinks

drill bits

reamers

cutters

inserts & cartridges

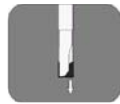
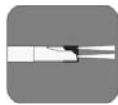
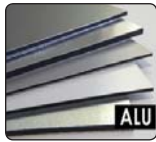
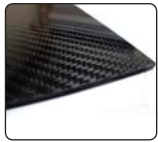

Escariador de Mango Cilindrico

D	d1	LT	L1	Z	CÓDIGO	€
5 H7	6	65	22	2	640100600502	
6 H7	6	70	28	2	640100600602	
7 H7	8	75	33	2	640100800702	
8 H7	8	80	38	2	640100800802	
9 H7	10	85	41	2	640101000902	
10 H7	10	90	43	2	640101001002	
12 H7	12	100	48	2	640101201202	
14 H7	14	110	57	2	640101401402	
16 H7	16	120	64	2	640101601602	
18 H7	18	130	73	2	640101801802	
20 H7	20	140	81	2	640102002002	

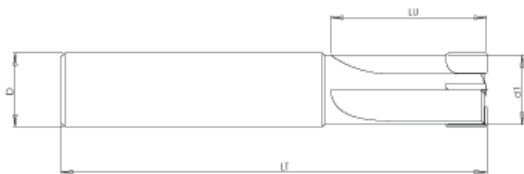

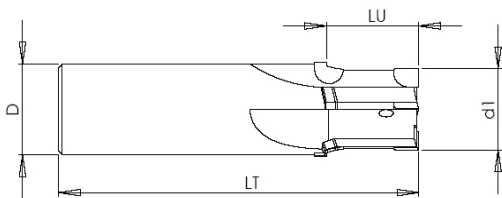
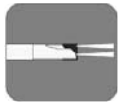
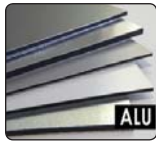
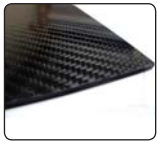

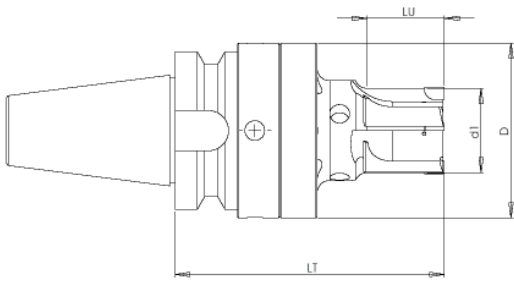
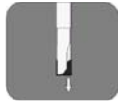
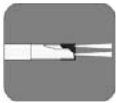
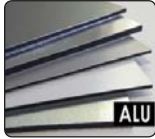
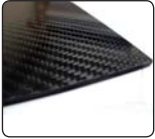

Il sistema di riferimento è costituito da:

Il sistema di riferimento è costituito da:

Il sistema di riferimento è costituito da:

Il sistema di riferimento è costituito da:

Il sistema di riferimento è costituito da:

Il sistema di riferimento è costituito da:

Il sistema di riferimento è costituito da:

Il sistema di riferimento è costituito da:

Il sistema di riferimento è costituito da:

Il sistema di riferimento è costituito da:



ZUBIOLA

DIAMOND TOOLS SOLUTIONS

AUTOMOTIVE AERONAUTICS INDUSTRY

PRODUCT CATALOGUE

countersinks

drill bits

reamers

cutters

inserts & cartridges

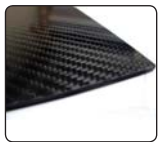

FMB001

D	d1	LT	R	LU	Z	CÓDIGO	€
4	4	60	2	10	1	620100400401	
6	6	80	3	10	2	620100600602	
8	8	80	4	10	2	620100800802	
10	10	80	5	10	2	602101001002	
12	12	100	6	10	2	620101201202	
16	16	130	8	10	3	602101601603	
20	20	160	10	13	3	620102002003	

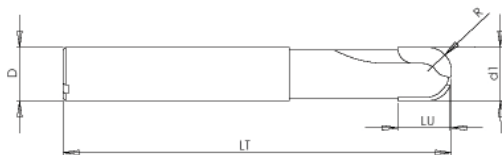

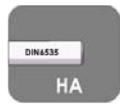
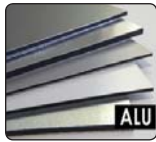
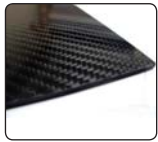
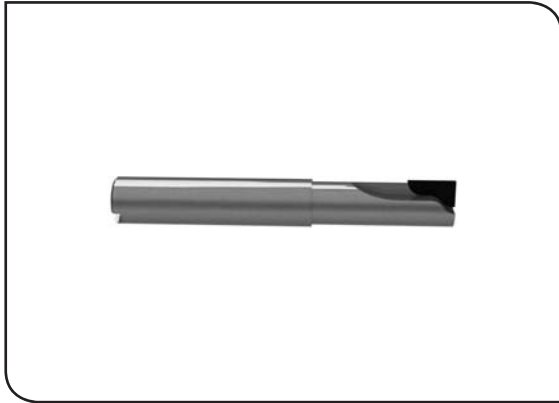

FMR001

D	d1	LT	R	LU	Z	CÓDIGO	€
6	4	75	0,3	2,5	2	620100600402	
6	5	75	0,3	3	2	620100600502	
8	6	100	1	6	2	620100800602	
10	8	100	2	7	2	620101000802	
12	10	100	3	8	2	620101201002	
16	12	100	4	9	2	620101601202	
16	16	130	5	11	2	620101601602	
20	20	160	6	13	2	620102002002	

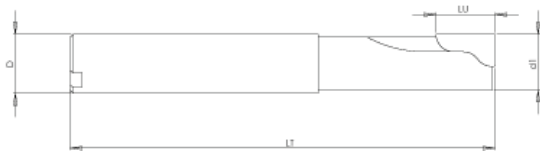

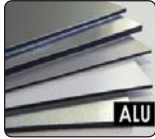
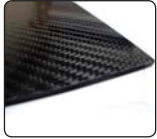

FMR002

D	d1	LT	LU	Z	CÓDIGO	€
6	6	60	10	2	620200600610	
6	6	60	15	2	620200600615	
6	6	80	20	2	620200600620	
8	8	80	10	2	620200800810	
8	8	80	15	2	620200800815	
8	8	80	20	2	620200800820	
10	10	80	10	2	620201001010	
10	10	80	15	2	620201001015	
10	10	80	20	2	620201001020	
12	12	100	10	2	620201201210	
12	12	100	15	2	620201201215	
12	12	100	20	2	620201201220	

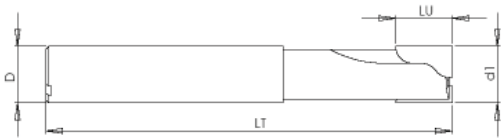

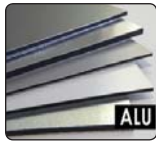
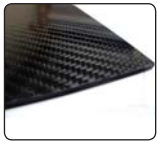
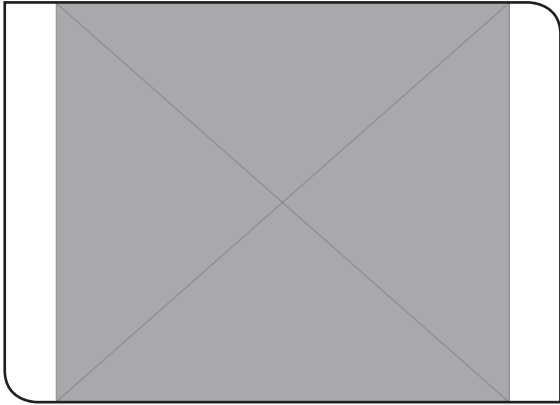

FMR003

D1	d1	LT	LU	Z	CÓDIGO	€
6	6	60	10	2	620300600610	
6	6	60	15	2	620300600615	
6	6	80	20	2	620300600620	
8	8	80	10	2	620300800810	
8	8	80	15	2	620300800815	
8	8	80	20	2	620300800820	
10	10	80	10	2	620301001010	
10	10	80	15	2	620301001015	
10	10	80	20	2	620301001020	
12	12	100	10	2	620301201210	
12	12	100	15	2	620301201215	
12	12	100	20	2	620301201220	

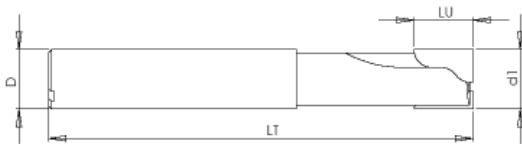

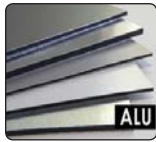
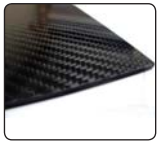
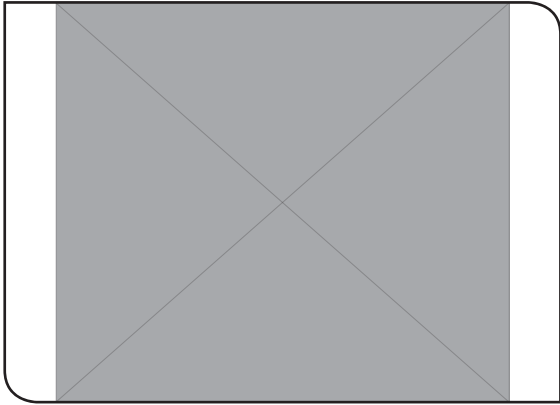

FMR004

D1	d1	LT	LU	Z	CÓDIGO	€
6	6	60	10	2	620400600610	
6	6	60	15	2	620400600615	
6	6	80	20	2	620400600620	
8	8	80	10	2	620400800810	
8	8	80	15	2	620400800815	
8	8	80	20	2	620400800820	
10	10	80	10	2	620401001010	
10	10	80	15	2	620401001015	
10	10	80	20	2	620401001020	
12	12	100	10	2	620401201210	
12	12	100	15	2	620401201215	
12	12	100	20	2	620401201220	

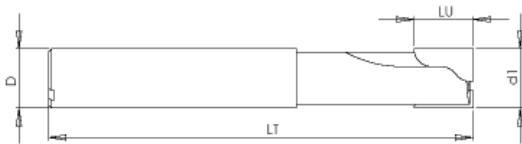

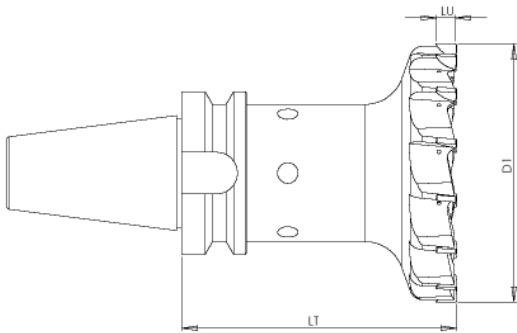
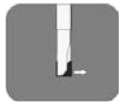
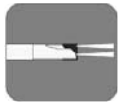
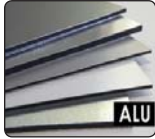
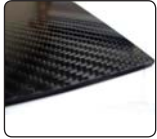
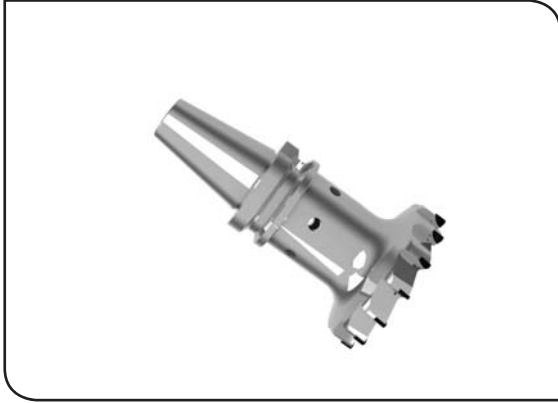

FPM001

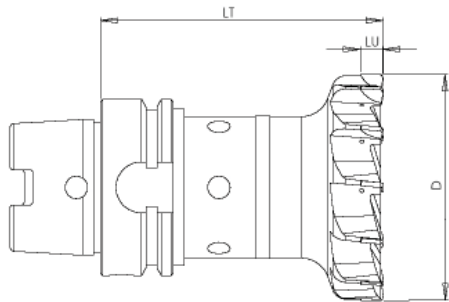
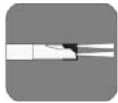
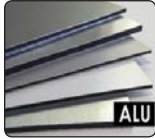
Tipo	D1	LT	LU	Z	CÓDIGO	€
MAS BT30	50	80	8	6	620113005006	
MAS BT30	63	100	8	8	620113006308	
MAS BT30	80	110	8	10	620113008010	
MAS BT40	50	80	8	6	620114005006	
MAS BT40	63	100	8	8	620114006308	
MAS BT40	80	110	8	10	620114008010	
MAS BT50	50	80	8	6	620115005006	
MAS BT50	63	100	8	8	620115006308	
MAS BT50	80	110	8	10	620115008010	
SK 30	50	80	8	6	620123005006	
SK 30	63	100	8	8	620123006308	
SK 30	80	110	8	10	620123008010	
SK 40	50	80	8	6	620124005006	
SK 40	63	100	8	8	620124006308	
SK 40	80	110	8	10	620124008010	
SK 50	50	80	8	6	620125005006	
SK 50	63	100	8	8	620125006308	
SK 50	80	110	8	10	620125008010	

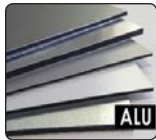

FPM002

Tipo	D1	LT	LU	Z	CÓDIGO	€
HSK 25	25	60	6	4	620232502504	
HSK 32	32	60	6	4	620233203204	
HSK 40	40	70	6	5	620234004005	
HSK 50	50	80	8	6	620035005006	
HSK 63	40	100	8	5	620236304005	
HSK 63	50	100	8	6	620236305006	
HSK 63	63	100	8	8	620236306308	
HSK 63	80	110	8	10	620236308010	
HSK 63	100	120	8	12	620236310012	
HSK 80	80	110	8	10	620238008010	
HSK 100	100	120	8	12	620231010012	

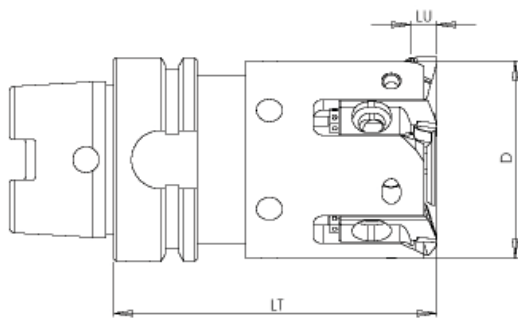
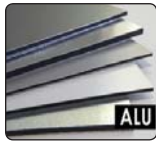
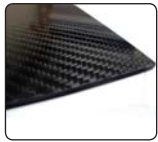

CPM001

Tipo	D	LT	L1	Z	CÓDIGO	€
MAS BT30	50	80	8	6	650113005006	
MAS BT30	63	100	8	8	650113006308	
MAS BT30	80	110	8	10	650113008010	
MAS BT40	50	80	8	6	650114005006	
MAS BT40	63	100	8	8	650114006308	
MAS BT40	80	110	8	10	650114008010	
MAS BT50	50	80	8	6	650115005006	
MAS BT50	63	100	8	8	650115006308	
MAS BT50	80	110	8	10	650115008010	
SK 30	50	80	8	6	650123005006	
SK 30	63	100	8	8	650123006308	
SK 30	80	110	8	10	650123008010	
SK 40	50	80	8	6	650124005006	
SK 40	63	100	8	8	650124006308	
SK 40	80	110	8	10	650124008010	
SK 50	50	80	8	6	650125005006	
SK 50	63	100	8	8	650125006308	
SK 50	80	110	8	10	650125008010	



CPM002

Tipo	D	LT	L1	Z	CÓDIGO	€
HSK 25	25	60	6	4	650232502504	
HSK 32	32	60	6	4	650233203204	
HSK 40	40	70	6	5	650234004005	
HSK 50	50	80	8	6	650235005006	
HSK 63	40	100	8	5	650236304005	
HSK 63	50	100	8	6	650236305006	
HSK 63	63	100	8	8	650236306308	
HSK 63	80	110	8	10	650236308010	
HSK 63	100	120	8	12	650236310012	
HSK 80	80	110	8	10	650238008010	
HSK 100	100	120	8	12	650231010012	

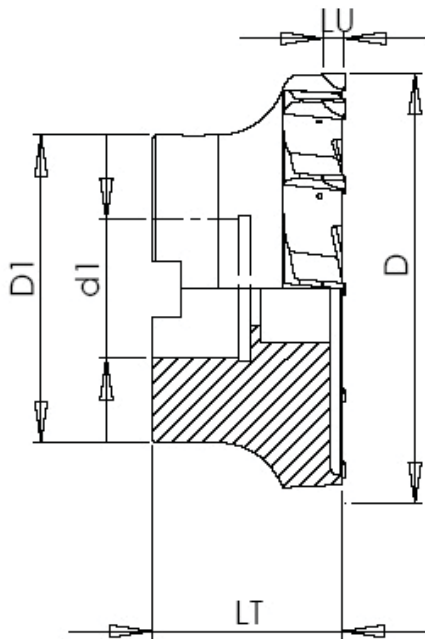
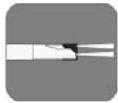
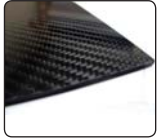
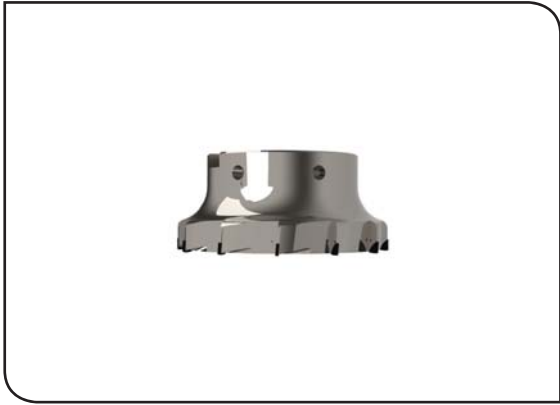

FPP001

D	D1	d1	LT	LU	Z	CÓDIGO	€
40	32	16 H7	35	9	4	630101604004	
50	40	22 H7	40	9	4	630102205004	
63	40	22 H7	45	9	5	630102206305	
80	48	27 H7	50	9	6	630102708006	
100	58	32 H7	60	9	7	630103210007	
125	70	40 H7	70	9	8	630104012508	

Il presente documento è riservato ai soli destinatari autorizzati. È vietata espressamente la ristampa o l'uso non autorizzato senza permesso scritto dalla Direzione Generale.

Il presente documento è riservato ai soli destinatari autorizzati. È vietata espressamente la ristampa o l'uso non autorizzato senza permesso scritto dalla Direzione Generale.

Il presente documento è riservato ai soli destinatari autorizzati. È vietata espressamente la ristampa o l'uso non autorizzato senza permesso scritto dalla Direzione Generale.

Il presente documento è riservato ai soli destinatari autorizzati. È vietata espressamente la ristampa o l'uso non autorizzato senza permesso scritto dalla Direzione Generale.

Il presente documento è riservato ai soli destinatari autorizzati. È vietata espressamente la ristampa o l'uso non autorizzato senza permesso scritto dalla Direzione Generale.



ZUBIOLA

DIAMOND TOOLS SOLUTIONS

AUTOMOTIVE AERONAUTICS INDUSTRY

PRODUCT CATALOGUE

inserts & cartridges

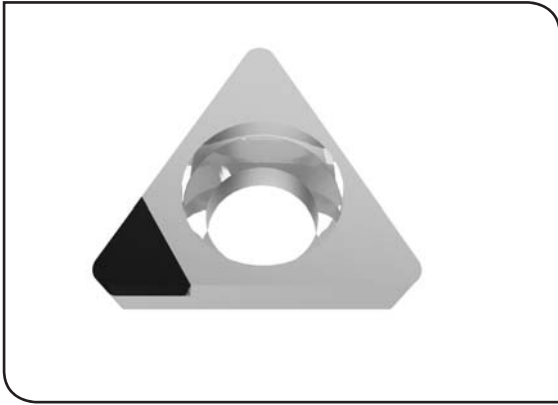

ALTERNO



Z 4+4

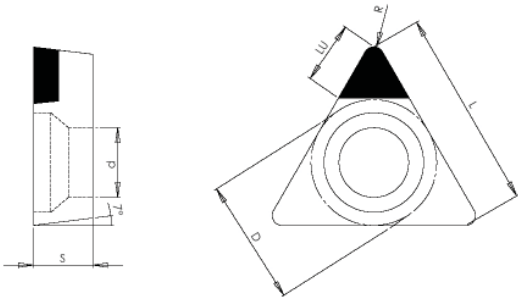

RB 9000

Tipo	D	R	d	S	CÓDIGO
TCG-	6,35	0,4	2,8	2,38	063067052413
TCG-	6,35	0,8	2,8	2,38	063067062813
TCG-		0,4	4,4	3,97	063067098413
TCG-		0,8	4,4	3,97	063067098813
TCG-	12,7	0,4	5,5	4,76	063067124413
TC-GT-	12,7	0,8	5,5	4,76	063067124813
TC-GT-	6,35	0,4	2,8	2,38	063068062413
TC-	6,35	0,8	2,8	2,38	063068062813
TC-		0,4	4,4	3,97	063068098413

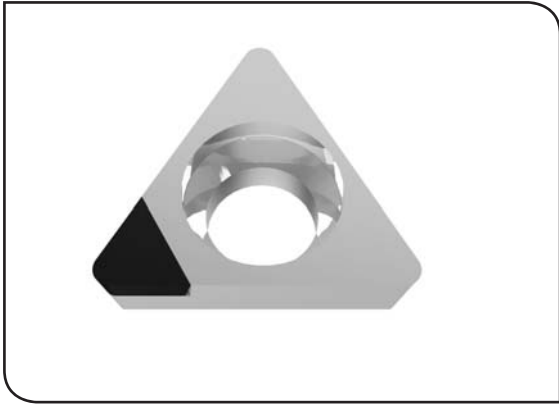

RB 9001

Tipo	D	R	d1	LU	S	CÓDIGO	€
TPG-	6,35	0,4	2,8		2,38	069067062413	
TPG-	6,35	0,8	2,8		2,38	069067062813	
TPG-		0,4	4,4		3,97	069067098413	
TPG-		0,8	4,4		3,97	069067098813	
TPG-	12,7	0,4	5,5		4,76	069067124413	
TP-GT-	12,7	0,8	5,5		4,76	069067124813	
TP-GT-	6,35	0,4	2,8		2,38	069068062413	
TP-	6,35	0,8	2,8		2,38	069068062813	
TP-		0,4	4,4		3,97	069068098413	

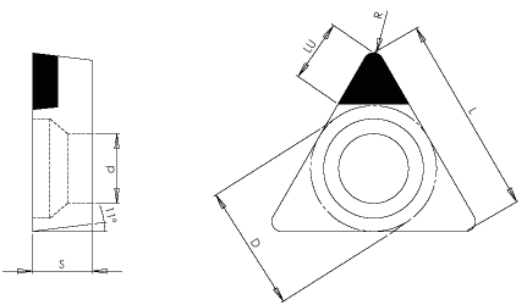

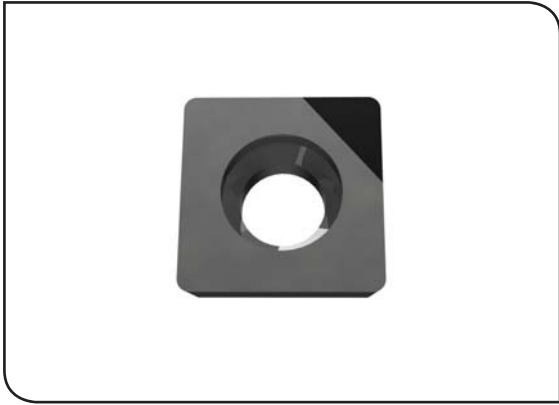

RB 9010

Tipo	D	R	d1	LU	S	CÓDIGO	€
SC-	6,35	0,4	2,8		2,38	053067062410	
SC-	6,35	0,8	2,8		2,38	053067062810	
SCG-		0,4	4,4		3,97	053067098410	
SCG-		0,8	4,4		3,97	053067098810	
SC-	12,7	0,4	5,5		4,76	053067124410	
SC-	12,7	0,8	5,5		4,76	053067124810	
SC-	6,35	0,4	2,8		2,38	053068062410	
SC-	6,35	0,8	2,8		2,38	053068062810	
SC-		0,4	4,4		3,97	053068098410	
SC-		0,8	4,4		3,97	053068098810	
SC-	12,7	0,4	5,5		4,76	053068124410	
SC-	12,7	0,8	5,5		4,76	053068124810	

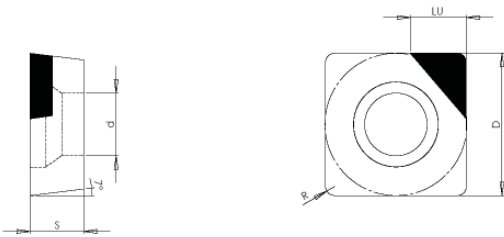

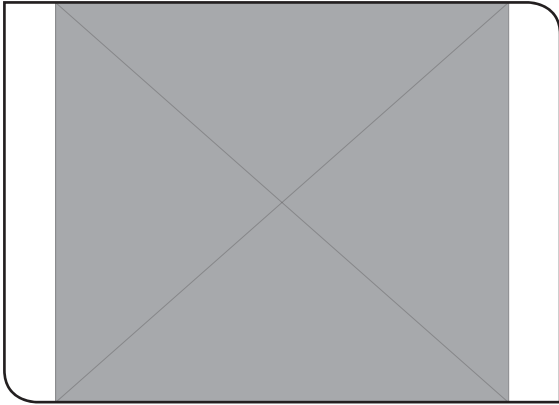

RB 9011

Tipo	D	R	d1	LU	S	CÓDIGO	€
SP-	6,35	0,4	2,8		2,38	059067062410	
SP-	6,35	0,8	2,8		2,38	059067062810	
SPG-		0,4	4,4		3,97	059067098410	
SPG-		0,8	4,4		3,97	059067098810	
SP-	12,7	0,4	5,5		4,76	059067124410	
SP-	12,7	0,8	5,5		4,76	059067124810	
SP-	6,35	0,4	2,8		2,38	059068062410	
SP-	6,35	0,8	2,8		2,38	059068062810	
SP-		0,4	4,4		3,97	059068098410	
SP-		0,8	4,4		3,97	059068098810	
SP-	12,7	0,4	5,5		4,76	059068124410	
SP-	12,7	0,8	5,5		4,76	059068124810	

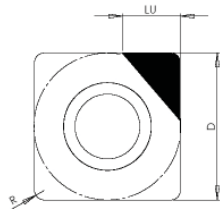
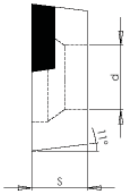

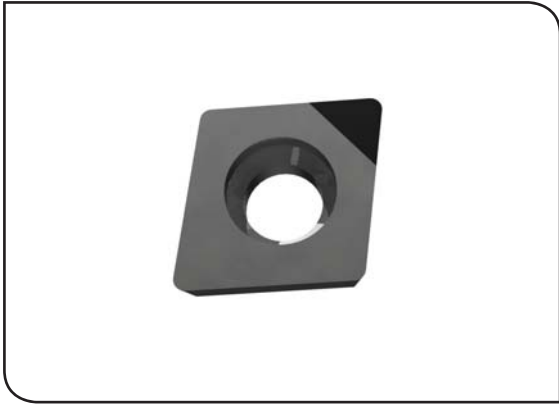

RB 9020

Tipo	D	R	d1	LU	S	CÓDIGO	€
CCG-	6,35	0,4	2,8		2,38	073067062413	
CCG-	6,35	0,8	2,8		2,38	073067062813	
CCG-		0,4	4,4		3,97	073067098413	
CCG-		0,8	4,4		3,97	073067098813	
CCG-	12,7	0,4	5,5		4,76	073067124413	
CC-GT-	12,7	0,8	5,5		4,76	073067124813	
CC-GT-	6,35	0,4	2,8		2,38	073068062413	
CC-	6,35	0,8	2,8		2,38	073068062813	
CC-		0,4	4,4		3,97	073068098413	

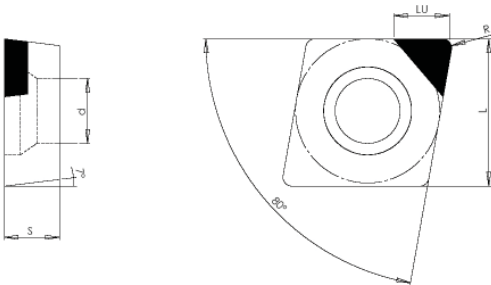

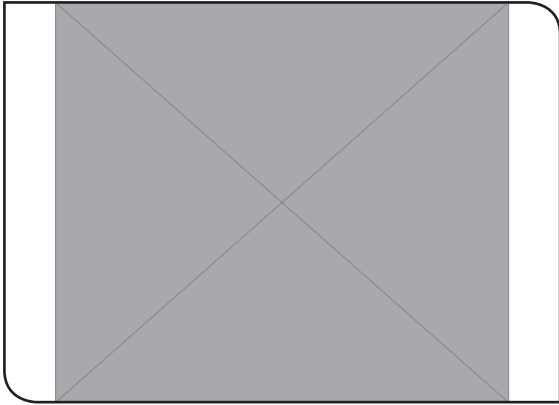

RB 9021

Tipo	D	R	d1	LU	S	CÓDIGO	€
CPG-	6,35	0,4	2,8		2,38	079067062413	
CPG-	6,35	0,8	2,8		2,38	079067062813	
CPG-		0,4	4,4		3,97	079067098413	
CPG-		0,8	4,4		3,97	079067098813	
CPG-	12,7	0,4	5,5		4,76	079067124413	
CP-GT-	12,7	0,8	5,5		4,76	079067124813	
CP-GT-	6,35	0,4	2,8		2,38	079068062413	
CP-	6,35	0,8	2,8		2,38	079068062813	
CP-		0,4	4,4		3,97	079068098413	

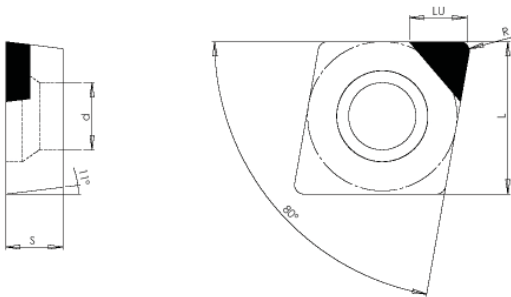

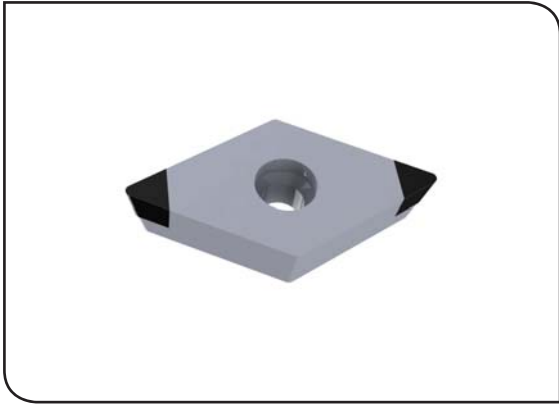

RB 9030

Tipo	D	R	d1	LU	S	CÓDIGO	€
DCG-	6,35	0,4	2,8		2,38	663063500200	
DCG-	6,35	0,8	2,8		2,38	663063500400	
DCG-		0,4	4,4		3,97	663095250400	
DCG-		0,8	4,4		3,97	663095250800	

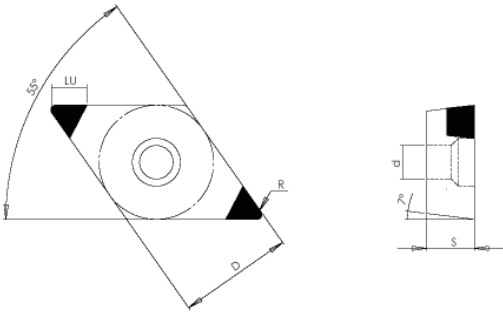

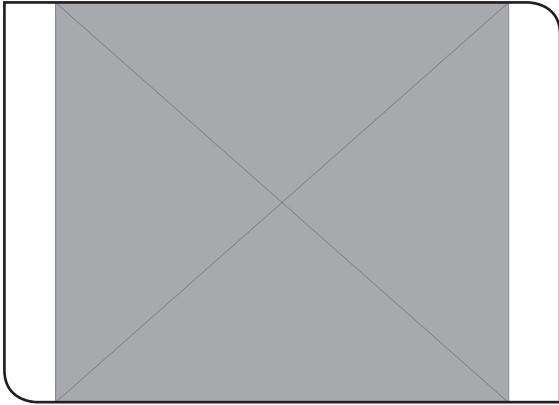
**RB 9031**

Tipo	D	R	d1	LU	S	CÓDIGO	€
DCG-	6,35	0,4	2,8		2,38	663163500200	
DCG-	6,35	0,8	2,8		2,38	663163500400	
DCG-		0,4	4,4		3,97	663195250400	
DCG-		0,8	4,4		3,97	663195250800	



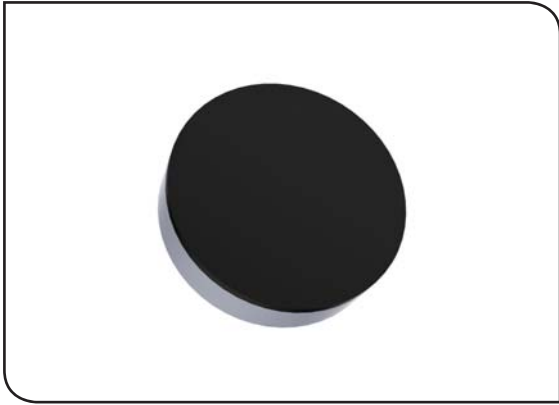

RB 9050

Tipo	D	S	CÓDIGO	€
RNG- N060300F- LF	6,35	3,18	665063500000	
RNG- N090300F- LF	9,525	3,18	665095250000	
RNG- N120300F- LF	12,7	3,18	665012700000	

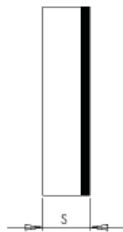
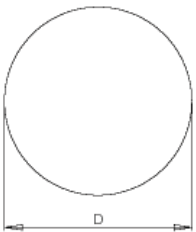

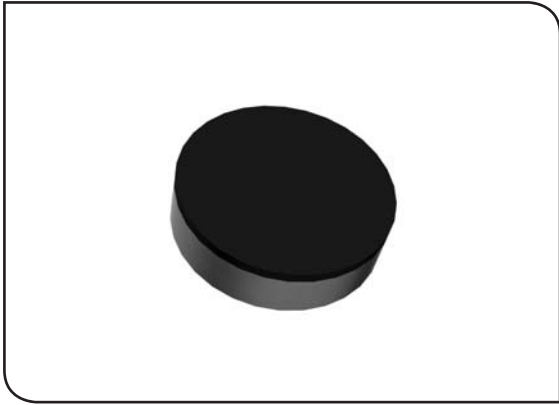
**RB 9051**

Tipo	D	S	CÓDIGO	€
RC-	9,525	3,18	665195250000	

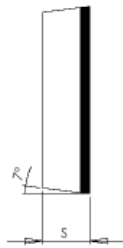
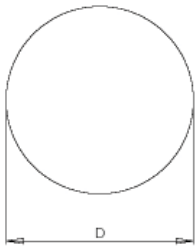

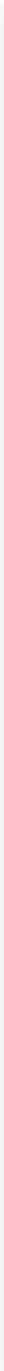
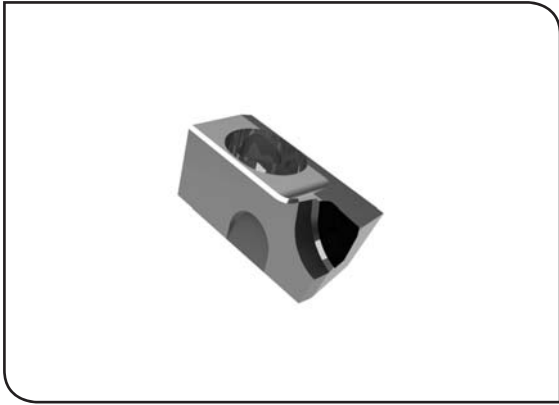

Il presente documento è riservato ai soli destinatari autorizzati. È vietata espressamente la ristampa o l'uso non autorizzato senza permesso scritto dalla Direzione Generale.

Il presente documento è riservato ai soli destinatari autorizzati. È vietata espressamente la ristampa o l'uso non autorizzato senza permesso scritto dalla Direzione Generale.

Il presente documento è riservato ai soli destinatari autorizzati. È vietata espressamente la ristampa o l'uso non autorizzato senza permesso scritto dalla Direzione Generale.

Il presente documento è riservato ai soli destinatari autorizzati. È vietata espressamente la ristampa o l'uso non autorizzato senza permesso scritto dalla Direzione Generale.

Il presente documento è riservato ai soli destinatari autorizzati. È vietata espressamente la ristampa o l'uso non autorizzato senza permesso scritto dalla Direzione Generale.

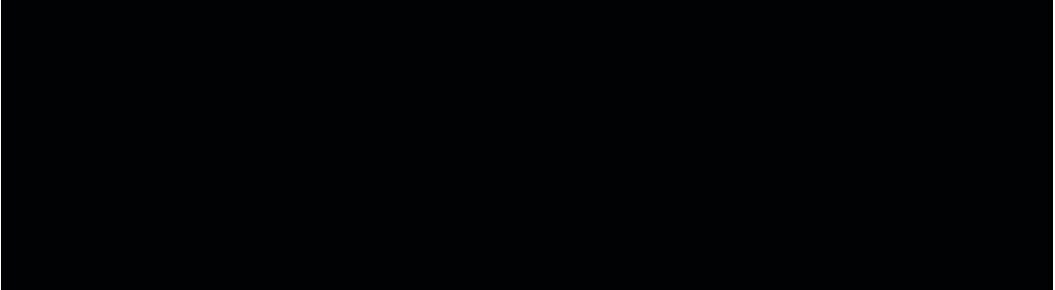

ZUBIOLA?

Pol. Basterretxe, 44
20720 AZKOITIA - Gipuzkoa - SPAIN
Tel.: +34 943 15 70 56
Fax: +34 943 15 00 26
zubiola@zubiola.es
www.zubiola.es
GPS : 43-10,1739N 2-18,1174O

