

CNC Rotary Table

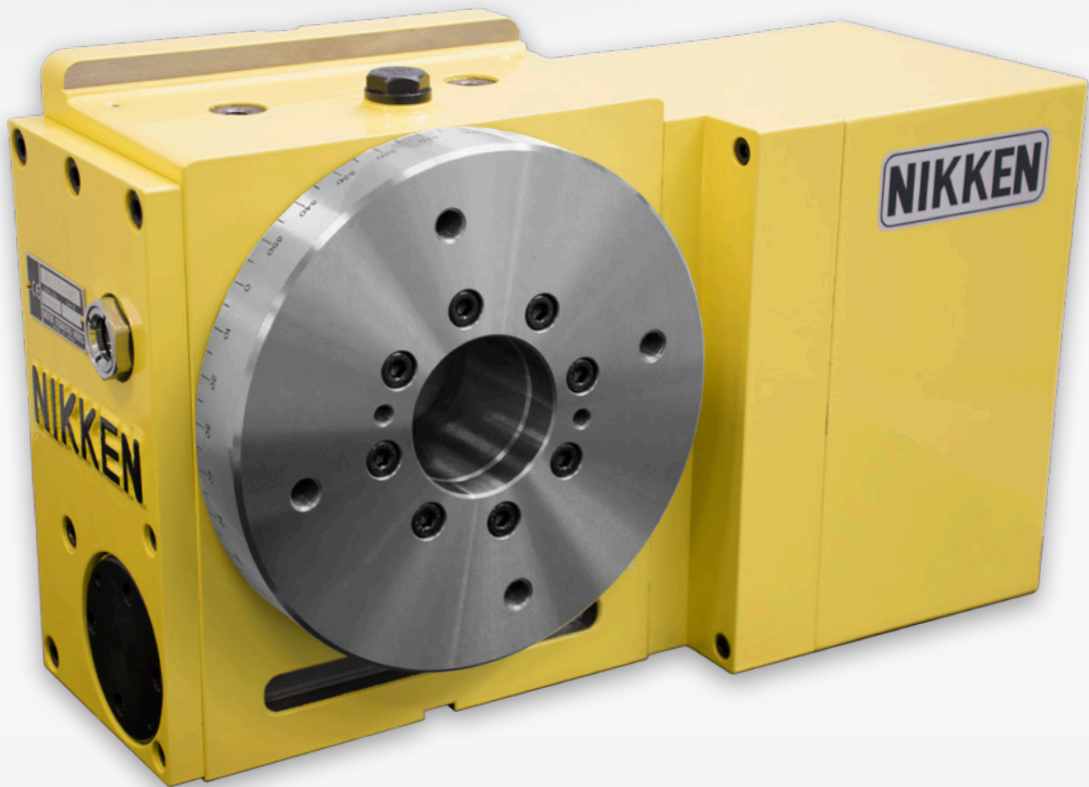

NCT200



NCT200 CNC Rotary Table

High Performance

Our NCT200 features a detachable faceplate system to provide versatility, a larger worm wheel for increased performance and the latest generation motors for simpler integration. The table provides much improved accuracy and a clamping torque of 900Nm, from a 200mm diameter table, our new NCT is the compact rotary to beat!

900Nm Brake Torque

Reliable indexing accuracy increases profitability

The super-high brake torque of 900Nm is generated by air supply only. Strong clamping torque and better indexing accuracy enhances productivity.

25% Greater Rigidity

Maintain high accuracy and reduce the total maintenance cost

The Drive system has been redesigned to provide a rigidity increase of 25%. High durability of the mechanism is allowed to maintain high accuracy and to accomplish high precision machining operation over the long term.

High Speed Performance

Reducing cycle time enhances productivity

A high speed "Z type" is also available with a modified worm gear resulting in double the rotational speed.



Customization Options

Face Plate

Rotary Joint

Support Table

NCT200E

Flange Plate Type
6 Port

Cylinder Type
6+1 Port

With Brake

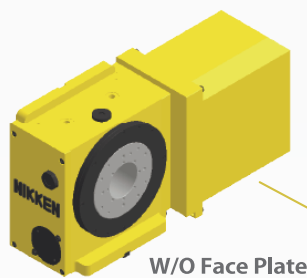

W/O Face Plate

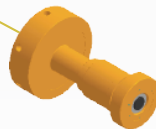

for NCT200E

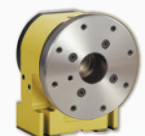

TAT-170N

NCT200

for NCT200

W/O Brake

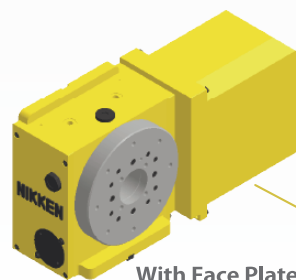

With Face Plate

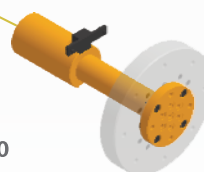
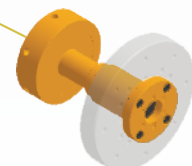

CST100-135

New Ultraslim Model

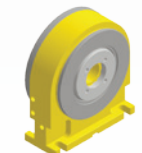

Coming Soon

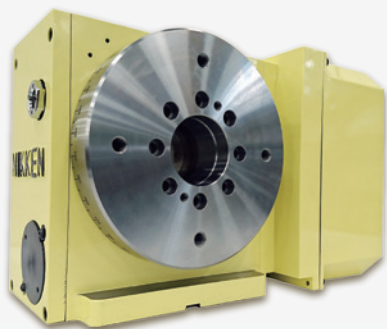

NCT200

With Face Plate

Standard

High Speed

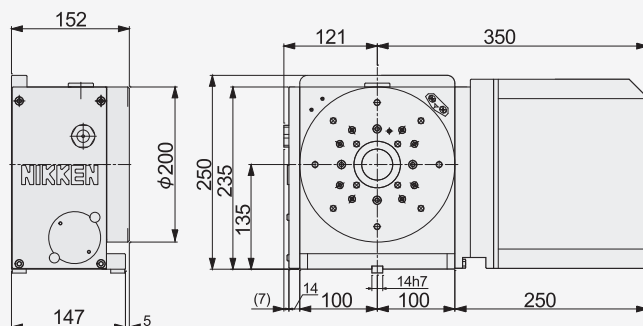

* Dimension: Right hand mounted with FANUC servomotor, motor covers will vary dependent on servomotor supplied, please check.

	STANDARD MODEL		HIGH-SPEED MODEL	
RIGHT HAND MOUNTED MOTOR	NCT200		NCTZ200	
LEFT HAND MOUNTED MOTOR	NCT200L		NCTZ200L	
FACE PLATE DIA.	φ200 mm		φ200 mm	
CLAMPING SYSTEM	AIR		AIR	
CLAMPING TORQUE	900 Nm		900 Nm	
ROTATION SPEED	33.3 min ⁻¹		66.6 min ⁻¹	
TOTAL REDUCTION RATIO	1/90		1/45	
DRIVING TORQUE	144Nm		115 Nm	
INDEXING ACCURACY	±20 sec		±20 sec	
REPEATABILITY	4 sec		4 sec	
MAX. WORK. LOAD	100 kg	VERTICAL	100 kg	VERTICAL
	200 kg	HORIZONTAL	200 kg	HORIZONTAL
NET WEIGHT	65 kg		65 kg	

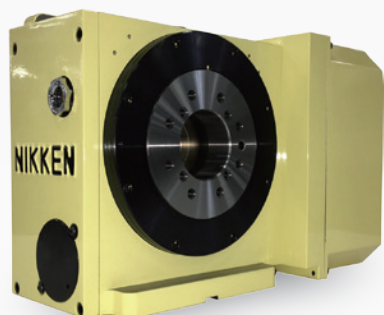

NCT200E

W/O Face Plate

Standard

High Speed

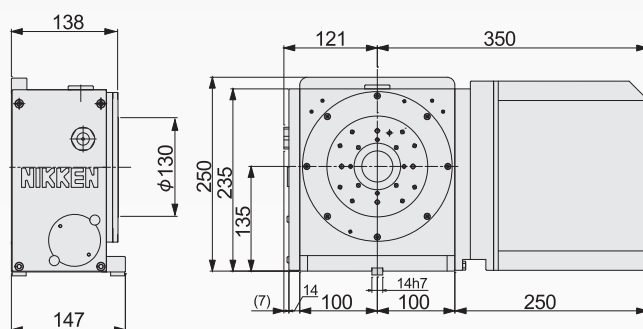

* Dimension: Right hand mounted with FANUC servomotor, motor covers will vary dependent on servomotor supplied, please check.

	STANDARD MODEL		HIGH-SPEED MODEL	
RIGHT HAND MOUNTED MOTOR	NCT200E		NCTZ200E	
LEFT HAND MOUNTED MOTOR	NCT200EL		NCTZ200EL	
SPINDLE DIA.	φ130 mm		φ130 mm	
CLAMPING SYSTEM	AIR		AIR	
CLAMPING TORQUE	900 Nm		900 Nm	
ROTATION SPEED	33.3 min ⁻¹		66.6 min ⁻¹	
TOTAL REDUCTION RATIO	1/90		1/45	
DRIVING TORQUE	144Nm		115 Nm	
INDEXING ACCURACY	±20 sec		±20 sec	
REPEATABILITY	4 sec		4 sec	
MAX. WORK. LOAD	100 kg	VERTICAL	100 kg	VERTICAL
	200 kg	HORIZONTAL	200 kg	HORIZONTAL
NET WEIGHT	62 kg		62 kg	

Specify your NCT200 quickly & easily

Coding System Explanation

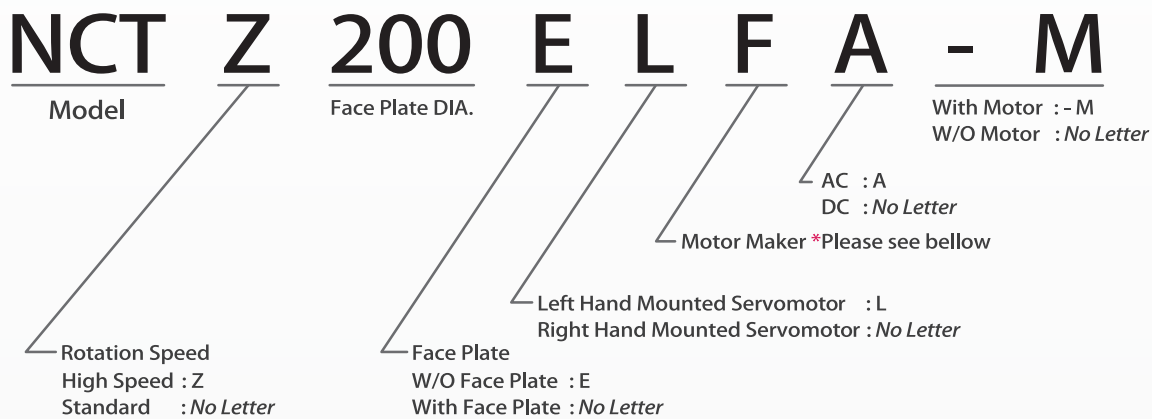

1. Select your servo.

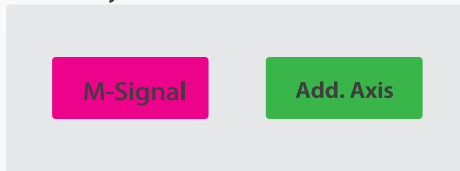

2 Right hand or Left hand?

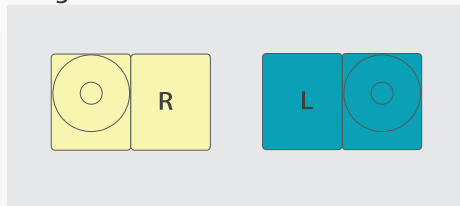

3. High Speed or Standard?

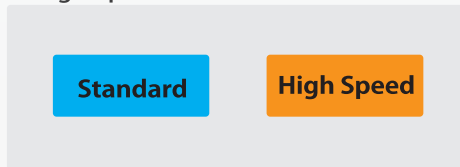

4. With or without the face plate?



*Makers for the Additional Axis Control

	Code No.	*Motor Maker Code No.
FANUC	<i>α</i> iF4/5000 <i>α</i> iS4/4000 <i>α</i> iS8/3000	F
MELDAS	HC52T HC53T HF54T HP54T	M
OSP	BL-ME24M50SN	OSP3
SIEMENS	1FT-6044-1AK71 1FK-7060	Z

Servomotor for Brother **SPEEDIO** is dedicated.

(Ex.) NCT□200□□SA-BR2

The last part of the product code must be "SA-BR2" in case of SPEEDIO.

*M signal control

	*Code No.
⌘21 Controller Nikken EZ Controller	AA21 EZ

5. Select optional accessories.

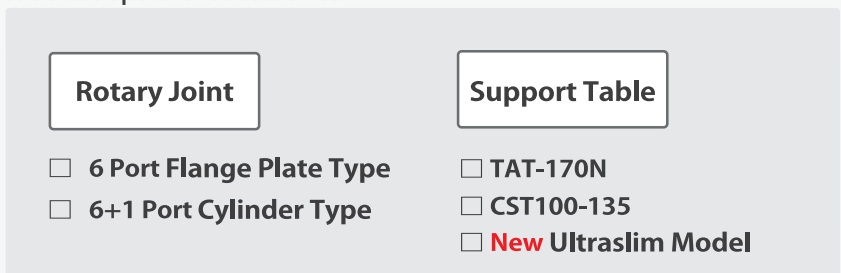

NIKKEN Innovation Centre Europe (NICe)
Advanced Manufacturing Park, Brunel Way
Rotherham, South Yorkshire S60 5FS

Telephone: +44 1709 366306

www.nikken-world.com



The Spirit of Innovation



Scan here for information about (NICe)
our European Innovation Centre

