

**NIKKEN**



# TOOL HUB

## PRODUCT CATALOGUE



The Spirit of Innovation





**NIKKEN**



# The Company

NIKKEN Kosakusho Limited was founded in 1958 in Osaka, Japan. Today, NIKKEN has business operations on three continents and offices in over seventy countries. NIKKEN employs around 100 people in Europe and over 700 globally, who are at the heart of the company and maintain the unique standards in quality and performance of the products. The range includes more than 15,000 products.

NIKKEN's market-leading solutions include:

- High-precision tool holders
- Modular boring system
- Tool presetters
- High performance CNC rotary axes
- Spindle optimisation solutions



The wide range of high-precision and durable solutions is used in demanding manufacturing environments in the fields of aerospace, medical, oil and gas, automotive, power, tooling and molding industries.

NIKKEN Kosakusho is constantly striving to improve its technologies through research and development, innovation and industry knowledge to ensure that your customers are even more competitive and successful.

NIKKEN Kosakusho Europe, based near Sheffield (UK), is a subsidiary of NIKKEN Kosakusho Works LTD in Japan, with the main responsibility to ensure the import and distribution of the complete complete NIKKEN product range in Europe. NIKKEN operates an industry-leading research and development NIKKEN Innovation Centre Europe (NICe), located at the heart of advanced manufacturing in Rotherham, UK.

## NIKKEN'S COMMITMENT TO SUSTAINABILITY

NIKKEN has been committed to sustainable development from the very beginning. Ultimately, the goal is to minimise environmental impact by ensuring that every NIKKEN solution and product offers the ultimate longevity, performance and durability.

# Spindle Connections

## HSK - ISO 12164-1/DIN69893 1/10

### HSK Form A

- Simultaneous collar and taper contact
- Driving grooves on the taper



### HSK Form E

- Symmetrical design without keyways
- Designed for high speeds



## IT - ISO DIN 69871

- Very common in Europe
- Requires pull stud
- Designation IT, DV or SK
- NIKKEN designation with collar contact NIT/ MIT



Unequal  
Driving  
Grooves

Orientation

## BT - JIS B 6339

- Requires pull stud
- Designation BT
- NIKKEN Designation with collar contact NBT/ MBT



Symmetrical  
Driving  
Grooves

## POLYGON - ISO/DIS 26623

- Polygon taper
- Simultaneous collar and taper contact
- Orientation groove





## OVERVIEW OF MOST COMMON CONNECTIONS

Flange Diameter	HSK (DIN)	IT/SK (DIN)	IT/SK (DIN) 2-Lock /BIG+	IT/SK (DIN) 3-Lock	BT (JIS)	BT 2-Lock/ BIG+	BT 3-Lock	Polygon
25mm	HSK25	-	-	-	-	-	-	-
32mm	HSK32	-	-	-	-	-	-	C3
40mm	HSK40	-	-	-	-	-	-	C4
46mm	-	-	-	-	BT30	NBT30	-	-
50mm	HSK50	-	-	-	-	-	-	C5
63mm	HSK63	IT40	NIT40	MIT40	BT40	NBT40	MBT40	C6
100mm	HSK100	IT50	NIT50	MIT50	BT50	NBT50	MBT50	C10

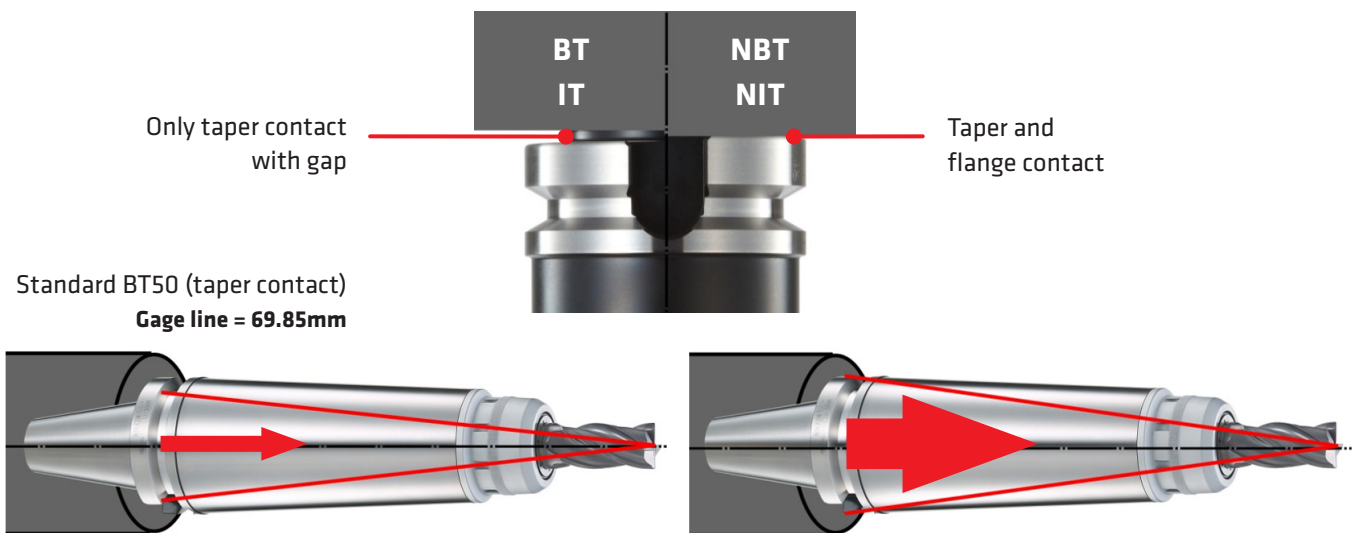

The common term in the machine industry for this option on the spindle is often called "BIG+" or "Dual Contact". NIKKEN's fully compatible products and solutions are based on our 2-LOCK (NBT/NIT) and 3-LOCK (MBT/MIT) steep taper shafts. The 2-Lock holders can also be used in conventional spindles. 3-Lock holders require a BIG+ or Dual Contact spindle.

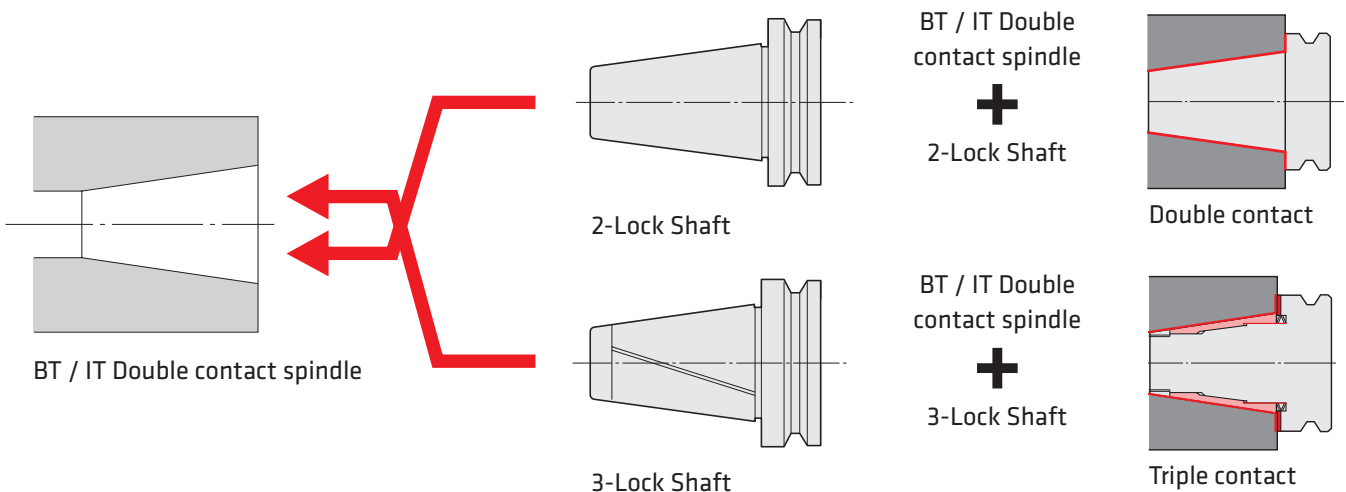

# System Overview

System	Slim Chuck	High Speed Slim Chuck	Mini Mini Chuck	Major Dream Holder
Designation	SK	SK-P	MMC	MD
System Properties & Accessories	Page 8 - 15	Page 8 - 15	Page 16 - 17	Page 18

The table refers to the respective page numbers

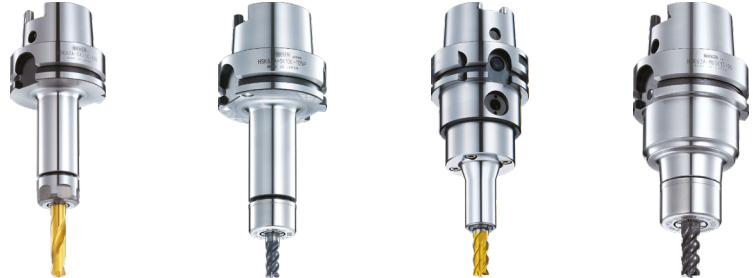

	Interface				
<b>HSK DIN 69893 Form A</b>	<b>HSK40A</b>	28 - 29		30 - 31	
	<b>HSK63A</b>	28 - 29		30 - 31	32 - 33
	<b>HSK100A</b>	28 - 29		32 - 33	32 - 33
<b>HSK DIN 69893 Form E</b>	<b>HSK25E</b>			30 - 31	
	<b>HSK32E</b>			30 - 31	
	<b>HSK40E</b>			30 - 31	
<b>IT Steep Taper Shaft DIN 69871</b>	<b>IT40</b>	40 - 41			40 - 41
	<b>IT50</b>	40 - 41			40 - 41
	<b>NIT40</b>	40 - 41			40 - 41
	<b>NIT50</b>	40 - 41			40 - 41
<b>BT JIS B6339 MAS 403</b>	<b>BT30</b>	48 - 49		50 - 51	52 - 53
	<b>BT40</b>	48 - 49		50 - 51	52 - 53
	<b>BT50</b>	48 - 49		50 - 51	52 - 53
	<b>NBT30</b>	48 - 49		50 - 51	
	<b>NBT40</b>	48 - 49		50 - 51	
<b>Polygon Shaft Polygon Hollow Taper Shaft ISO 26223-1</b>	<b>C4</b>	62 - 63			
	<b>C6</b>	62 - 63			62 - 65
	<b>C8</b>	62 - 63			
<b>Cylinder Shaft (Multi-Lock Extension)</b>	<b>K20</b>				64 - 65
	<b>K22</b>				
	<b>K25</b>				
	<b>K32</b>				64 - 65
	<b>K42</b>				

<b>Accessories</b>	66 - 69
<b>Spindle Connections</b>	70 - 71
<b>ISO Index</b>	72





Multi-Lock Milling Chuck	High Speed Multi-Lock Milling Chuck	Zero Fit Slim Chuck	Zero Fit Multi-Lock Milling Chuck	Arbors
C	C-G	SZF	CZF	FMH
Page 19 - 24	Page 19 - 24	Page 25 - 27	Page 25 - 27	Page 38, 46, 60 - 61



34 - 35	34 - 35	36 - 37	36 - 37	38
34 - 35	34 - 35	36 - 37	36 - 37	38
	34 - 35			
42 - 43		44 - 45	44 - 45	
42 - 43		44 - 45	44 - 45	
				46
				46
54 - 55	56 - 57	58 - 59	60 - 61	60 - 61
54 - 55	56 - 57	58 - 59	60 - 61	60 - 61
54 - 55	56 - 57	58 - 59	60 - 61	60 - 61
54 - 55	56 - 57			
54 - 55	56 - 57			
54 - 55	56 - 57			
64 - 65				
64 - 65				

The Slim Chuck incorporates NIKKEN's exclusive TiN (titanium nitride) bearing disc technology. This allows improved clamping of the tool with very high concentricity.



## FEATURES

- Slim and compact body and clamping nut
- 8° collet with face contact in the clamping nut
- Superior clamping force
- Patented unique TiN bearing washer
- Simple, compact and versatile
- Jet & Ick available
- Clamping range:  $\varnothing$  0.7-25.4mm

## CONCENTRICITY OF COLLET (SK)

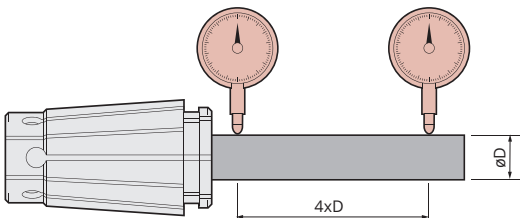

Collet Type	Max. Concentricity	
	At the Collet	At 4×D
Standard	1 $\mu$	5 $\mu$
P	1 $\mu$	3 $\mu$
A/AC	1 $\mu$	3 $\mu$

Standard = universal  
 P = Precision collet  
 A = Precision collet without clamping range / min. h8 shank  
 AC = Precision collet without clamping range / min. h8 shank / metal sealing

## TiN BEARING WASHER

Simple and compact design for high-speed applications

TiN Bearing Nut

8° collet with higher stiffness for better accuracy and higher clamping force

Special coating for high efficiency

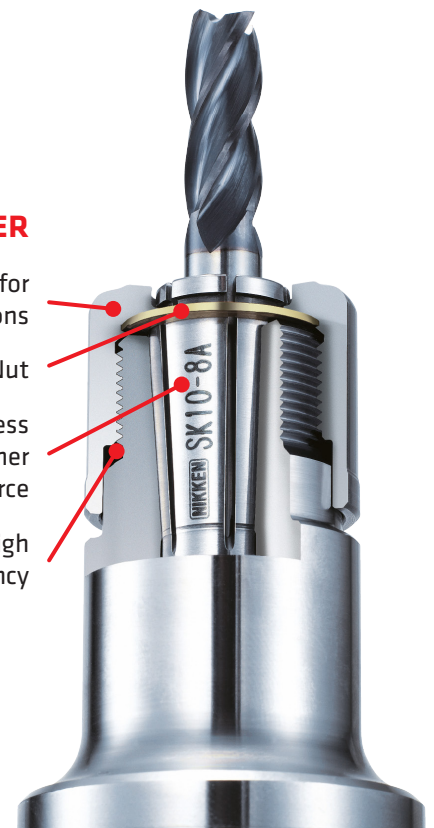



Standard Slim Chuck / High Speed Slim Chuck-P

Size	∅ Outer Contour	∅ Clamping Range
SK6	19.5	0.7-6.0
SK10	27.5	1.75-10.0
SK16	40	2.75-16.0
SK20	48.5	3.5-20.0

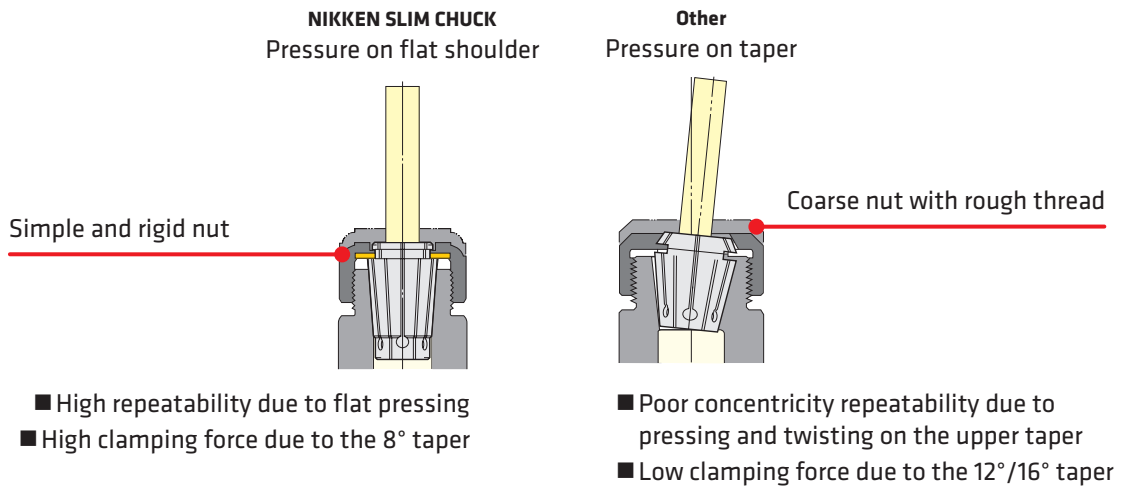

**RUNOUT VS. WEAR AND TEAR (+30% SERVICE LIFE)**

The lower diagram shows the dependence of tool life on changed runout. To illustrate this, our Zero Fit Slim Chuck was used for profile milling of titanium (Ti6Al-4V) and the runout was specifically changed.

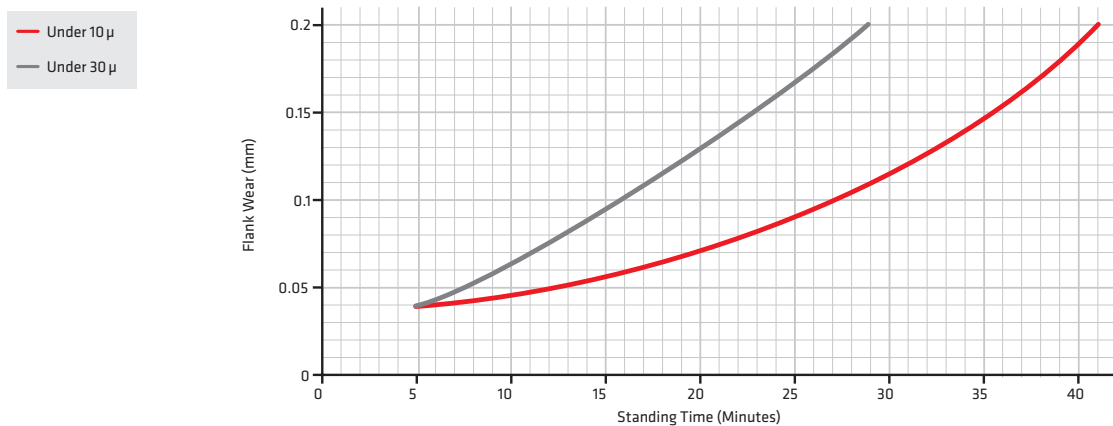

SKT-P - conical design  
(only in conjunction with 2-Lock or 3-Lock)

## SLIM CHUCK COLLETS

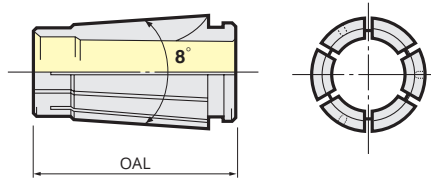

### Designation Structure

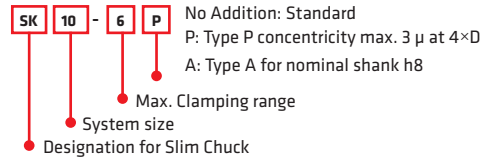

Designation	Clamping Range
SK6-0.8	0.7-0.8
SK6-1	0.9-1.0
SK6-1.25	1.15-1.25
SK6-1.5	1.3-1.5
SK6-1.75	1.55-1.75
SK6-2	1.8-2.0
SK6-2.25	2.05-2.25
SK6-2.5	2.3-2.5
SK6-2.75	2.55-2.75
SK6-3	2.8-3.0
SK6-3.5	3.0-3.5
SK6-4	3.5-4.0
SK6-4.5	4.0-4.5
SK6-5	4.5-5.0
SK6-5.5	5.0-5.5
SK6-6	5.5-6.0
SK10-1	0.9-1.0
SK10-1.25	1.15-1.25
SK10-1.5	1.3-1.5
SK10-1.75	1.55-1.75
SK10-2	1.75-2.0
SK10-2.25	2.0-2.25
SK10-2.5	2.25-2.5
SK10-2.75	2.5-2.75
SK10-3	2.75-3.0
SK10-3.5	3.0-3.5
SK10-4	3.5-4.0
SK10-4.5	4.0-4.5
SK10-5	4.5-5.0
SK10-5.5	5.0-5.5
SK10-6	5.5-6.0
SK10-6.5	6.0-6.5
SK10-7	6.5-7.0
SK10-7.5	7.0-7.5
SK10-8	7.5-8.0
SK10-8.5	8.0-8.5
SK10-9	8.5-9.0
SK10-9.5	9.0-9.5
SK10-10	9.5-10.0

Designation	Clamping Range
SK16-3	2.75-3.0
SK16-3.5	3.0-3.5
SK16-4	3.5-4.0
SK16-4.5	4.0-4.5
SK16-5	4.5-5.0
SK16-5.5	5.0-5.5
SK16-6	5.5-6.0
SK16-6.5	6.0-6.5
SK16-7	6.5-7.0
SK16-7.5	7.0-7.5
SK16-8	7.5-8.0
SK16-8.5	8.0-8.5
SK16-9	8.5-9.0
SK16-9.5	9.0-9.5
SK16-10	9.5-10.0
SK16-10.5	10.0-10.5
SK16-11	10.5-11.0
SK16-11.5	11.0-11.5
SK16-12	11.5-12.0
SK16-12.5	12.0-12.5
SK16-13	12.5-13.0
SK16-13.5	13.0-13.5
SK16-14	13.5-14.0
SK16-14.5	14.0-14.5
SK16-15	14.5-15.0
SK16-15.5	15.0-15.5
SK16-16	15.5-16.0

Designation	Clamping Range
SK20-4	3.5-4.0
SK20-4.5	4.0-4.5
SK20-5	4.5-5.0
SK20-5.5	5.0-5.5
SK20-6	5.5-6.0
SK20-6.5	6.0-6.5
SK20-7	6.5-7.0
SK20-7.5	7.0-7.5
SK20-8	7.5-8.0
SK20-8.5	8.0-8.5
SK20-9	8.5-9.0
SK20-9.5	9.0-9.5
SK20-10	9.5-10.0
SK20-10.5	10.0-10.5
SK20-11	10.5-11.0
SK20-11.5	11.0-11.5
SK20-12	11.5-12.0
SK20-12.5	12.0-12.5
SK20-13	12.5-13.0
SK20-13.5	13.0-13.5
SK20-14	13.5-14.0
SK20-14.5	14.0-14.5
SK20-15	14.5-15.0
SK20-15.5	15.0-15.5
SK20-16	15.5-16.0
SK20-16.5	16.0-16.5
SK20-17	16.5-17.0
SK20-17.5	17.0-17.5
SK20-18	17.5-18.0
SK20-18.5	18.0-18.5
SK20-19	18.5-19.0
SK20-19.5	19.0-19.5
SK20-20	19.5-20.0

SK6 OAL = 25  
 SK10 OAL = 30.5  
 SK16 OAL = 45  
 SK20 OAL = 54.2

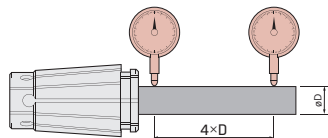

Collet Type	Max. Concentricity	
	At the Collet	At 4×D
Standard	1 μ	5 μ
P	1 μ	3 μ
A/AC	1 μ	3 μ

Standard = universal  
 P = Precision collet  
 A = Precision collet without clamping range / min. h8 shank  
 AC = Precision collet without clamping range / min. h8 shank / metal sealing

### Slim Chuck Collets Type A

SK6-3A, 4A, 5A, 6A

SK10-3A, 4A, 5A, 6A, 8A, 10A

SK16-3A, 4A, 5A, 6A, 8A, 10A, 12A, 14A, 16A

SK20-4A, 5A, 6A, 8A, 10A, 12A, 16A, 20A

Other dimensions upon request



## COLLETS FOR TOOLS WITH INTERNAL COOLING (SK-AC)

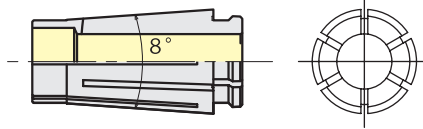

Designation Structure

**SK 10 - 6 AC**

- For tools with IK
- Max clamping range
- System size
- Designation for Slim Chuck

SK-AC the recommended shank tolerance is min. h8.  
Runout with AC collet is max.  $3\ \mu$  at  $4 \times D$

System Size	Designation	Clamping Diameter
SK6	SK6-3AC	3.0
	SK6-4AC	4.0
	SK6-5AC	5.0
	SK6-6AC	6.0
SK10	SK10-3AC	3.0
	SK10-4AC	4.0
	SK10-5AC	5.0
	SK10-6AC	6.0
	SK10-7AC	7.0
	SK10-8AC	8.0
	SK10-9AC	9.0
SK16	SK10-10AC	10.0
	SK16-6AC	6.0
	SK16-7AC	7.0
	SK16-8AC	8.0
	SK16-9AC	9.0
	SK16-10AC	10.0
	SK16-11AC	11.0
	SK16-12AC	12.0
	SK16-13AC	13.0
	SK16-14AC	14.0
SK20	SK16-15AC	15.0
	SK16-16AC	16.0
	SK20-12AC	12.0
	SK20-16AC	16.0
	SK20-20AC	20.0

### Quick and easy solution for internal cooling

Slim Chuck  
Major Dream

SK Standard Nut  
SKT / MDSK Standard Nut

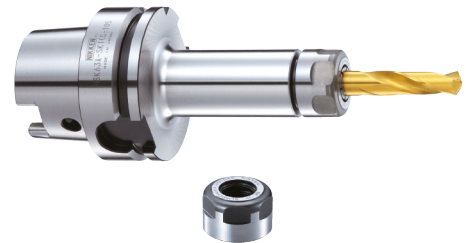

SK-AC Collet



**Caution!**  
Coolant could escape undesirably if the tool has a flat area (Weldon / Whistle-Notch)

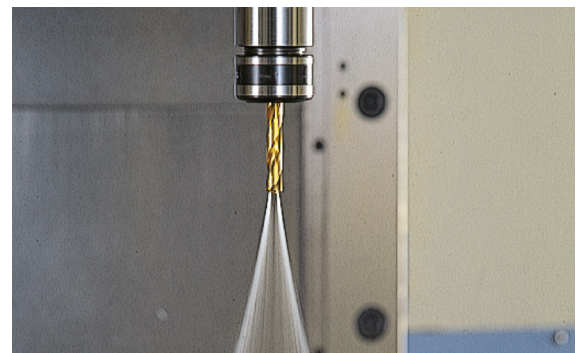

In this box SK collets can be organised and safely stored.



Designation	Collet	Capacity (Stk.)	Dimension
SKBX-10	SK10	60	W300 x H100 x D200mm
SKBX-16	SK16	24	
SKBX-610	SK6	26	
SKBX-610	SK10	40	
SKBX-1316	SK16	14	

## SLIM CHUCK COOLANT SOLUTIONS

### CUTTING TOOLS WITH INNER COOLING

### JET COOLING SYSTEM

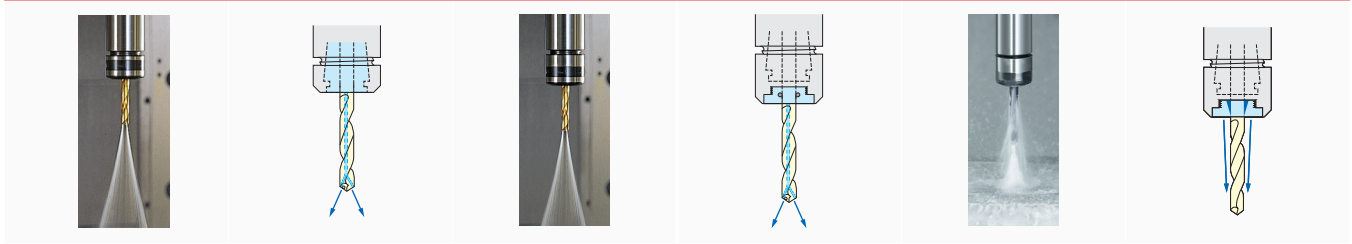

**1** Standard Nut and SK-AC Collet

**2** J-Type Nut with Standard Collet and O-Ring Cover

**3** J-Type Nut with Standard Collet and Jet Cover

**1** Cutting Tool with Internal Cooling  
SK STANDARD NUT AND SK-AC COLLET

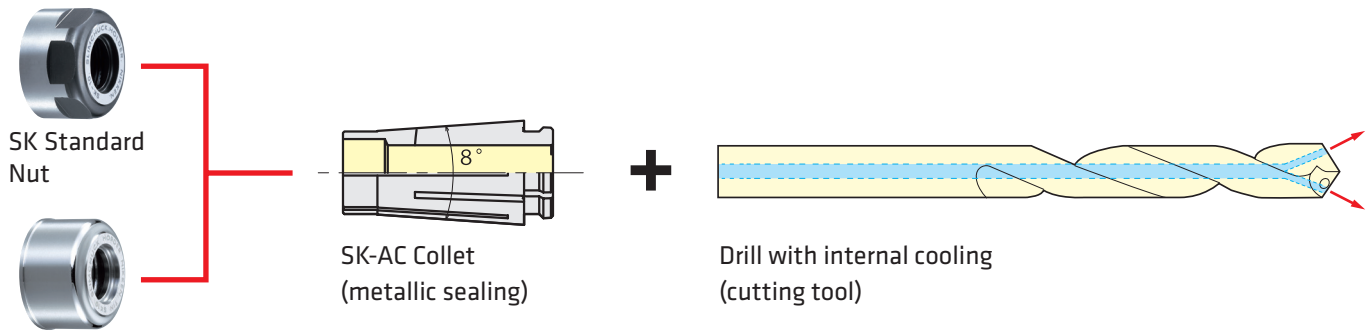

SKT / MDSK standard nut  
(for GH roller wrench)

When using the type A or AC collet, the functional length LF is reduced by 3mm. Systems: SK = Slim Chuck / SK\_P = Slim Chuck High Speed / MDSK = Major Dream

System	Standard Nut with Open End Wrench		Nut with Roller Wrench		AC Collet (optional)
	Nut Designation	Open End Wrench (optional)	Nut Designation	Roller Key (optional)	
SK6 SK6 (P)	SKN-6WK	SKL-6W	SKN-6WK (GH)	GH6	SK6-3AC, 4AC, 5AC, 6AC
SKT6 MDSK6	SKTN-6K		MDSKN-6K		
SK10 SK10 (P)	SKN-10K	SKL-10	SKN-10K (GH)	GH10	SK10-3AC, 4AC, 5AC, 6AC, 7AC, 8AC, 9AC, 10AC
SKT10 MDSK10	SKTN-10K		MDSKN-10K		
SK16 SK16 (P)	SKN-16B	9HC16	SKN-16B (GH)	GH16	SK16-6AC, 7AC, 8AC, 9AC, 10AC, 11AC, 12AC, 13AC, 14AC, 15AC, 16AC
SKT16 MDSK16	SKTN-16B		MDSKN-16B		
SK20 SK20 (P)	SKN-20B	9HC22	SKN-20B (GH)	GH20	SK20-12AC, 16AC, 20AC, 25AC
SKT20 MDSK20	SKTN-20B		MDSKN-20B		



**2** Cutting Tool with Internal Cooling (Drill)  
**JET TYPE NUT WITH STANDARD COLLET AND COVER CAP WITH O-RING**

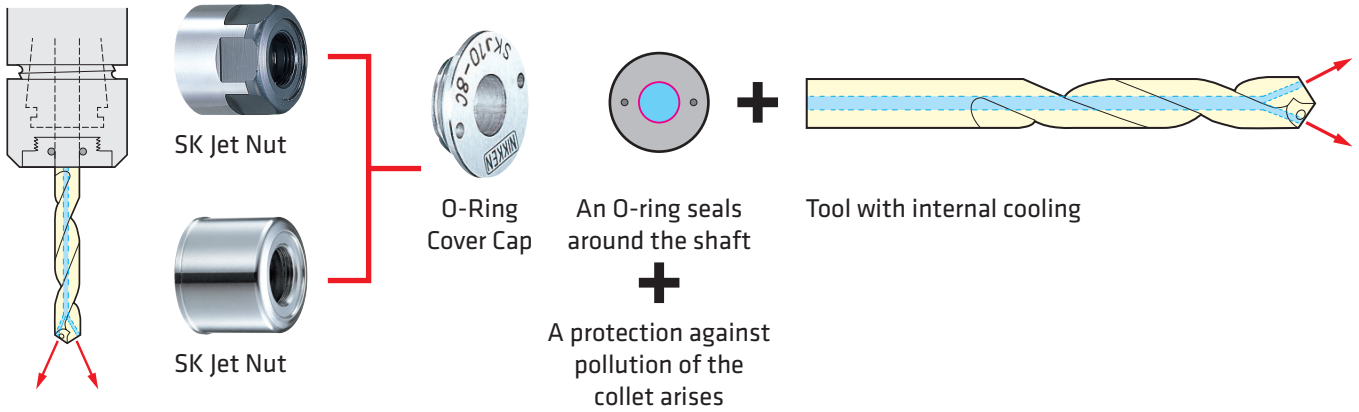

The Jet nut is 6mm longer than the standard nut. When using the Type A or AC Collet, the functional length LF is reduced by 3mm.

System	Collet Selection	Accessories shown are optional				
		Jet Nut		Key	O-Ring Cover Cap	Key for Cover Cap
		SK, SK-P	SKT, MDSK			
<b>SK6, SK6 (P) (High Speed) MDSK6 SKT6</b>	SK6-□.□	SKN-6WKJ	SKTN-6KJ	SKL-6W		
	SK6-□.□P	SKN-6WKJ (GH)	MDSKN-6KJ			SKJL-6
	SK6-□.□A					
<b>SK10, SK10 (P) (High Speed) MDSK10 SKT10</b>	SK10-□.□	SKN-10KJ	SKTN-10KJ	SKL-10		
	SK10-□.□P	SKN-10KJ (GH)	MDSKN-10KJ			SKJL-10
	SK10-□.□A					
<b>SK16, SK16 (P) (High Speed) MDSK16 SKT16</b>	SK16-□.□	SKN-16BJ	MDSKN-16BJ	9HC16		
	SK16-□.□P	SKN-16BJ (GH)	MDSKN-16BJ			SKJL-16
	SK16-□.□A					
<b>SK20, SK20 (P) (High Speed) MDSK20 SKT20</b>	SK20-□.□	SKN-20BJ	SKTN-20BJ	9HC22		
	SK20-□.□P	SKN-20BJ (GH)	MDSKN-20BJ			SKJL-25
	SK20-□.□A					

**3** Cutting tool without internal cooling (Jet System)  
**JET TYPE NUT WITH STANDARD COLLET AND JET COVER CAP**



The Jet nut is 6mm longer than the standard nut. When using the Type A or AC collet, the functional length LF is reduced by 3mm.

System	Collet Selection	Accessories shown are optional				
		SK, SK-P	Jet Nut	Key	O-Ring Cover Cap	Key for Cover Cap
		SKN, SK-P	SKT, MDSK			
<b>SK6, SK6 (P) (High Speed) MDSK6 SKT6</b>	SK6-□.□	SKN-6WKJ	SKTN-6KJ	SKL-6W		
	SK6-□.□P	SKN-6WKJ (GH)	MDSKN-6KJ			
	SK6-□.□A					
<b>SK10, SK10 (P) (High Speed) MDSK10 SKT10</b>	SK10-□.□	SKN-10KJ	SKTN-10KJ	SKL-10		
	SK10-□.□P	SKN-10KJ (GH)	MDSKN-10KJ			
	SK10-□.□A					
<b>SK16, SK16 (P) (High Speed) MDSK16 SKT16</b>	SK16-□.□	SKN-16BJ	MDSKN-16BJ	9HC16		
	SK16-□.□P	SKN-16BJ (GH)	MDSKN-16BJ			
	SK16-□.□A					
<b>SK20, SK20 (P) (High Speed) MDSK20 SKT20</b>	SK20-□.□	SKN-20BJ	SKTN-20BJ	9HC22		
	SK20-□.□P	SKN-20BJ (GH)	MDSKN-20BJ			
	SK20-□.□A					



**NIKKEN SLIM CHUCK**  
Pressure on flat shoulder

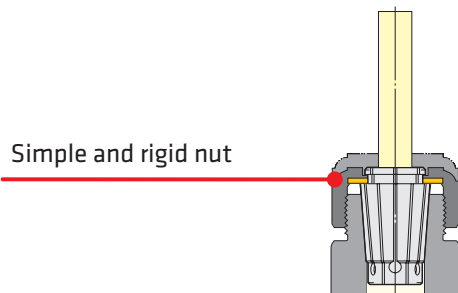

- High repeatability due to flat pressing
- High clamping force due to the 8° taper

**Other**  
Pressure on cone

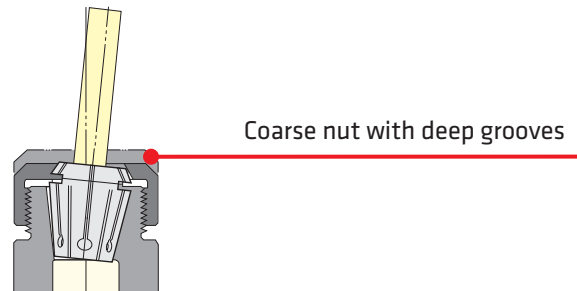

- Poor concentricity repeatability due to pressing and twisting on the upper cone
- Low clamping force due to the 12°/16° taper

Nikken		ER	
SK6	25	ER11	18
SK10	30.5	ER16	27.5
SK16	45	ER25	34
SK20	54.2	ER32	40

The new NIKKEN Mini Mini Advanced Alpha Chuck is the most effective product for machining with small diameters and applications with limited space or problematic interfering contours, diameters and for applications with limited space or problematic interfering contours.



## PROPERTIES

- Compact design without clamping nut
- Improved internal mechanism
- Clamping/releasing with a single key
- 8° collet with cylinder guide
- New type: HSK "AT" with direct feed via tie rod centrally from the rear
- Jet & Ick available
- Clamping range:  $\varnothing$  1-12mm

## RUNOUT OF COLLET (PMK, VMK)

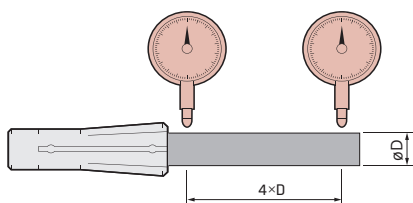

Max. Concentricity	
At the Collet	At 4×D
1μ	3μ

## NEWEST GENERATION OF CLAMPING

- Optimised materials and heat treatment
- Improved guidance of the tie rod due to one-piece construction
- Smooth clamping/release due to double TiN bearing washer
- Improved gear design for increased efficiency

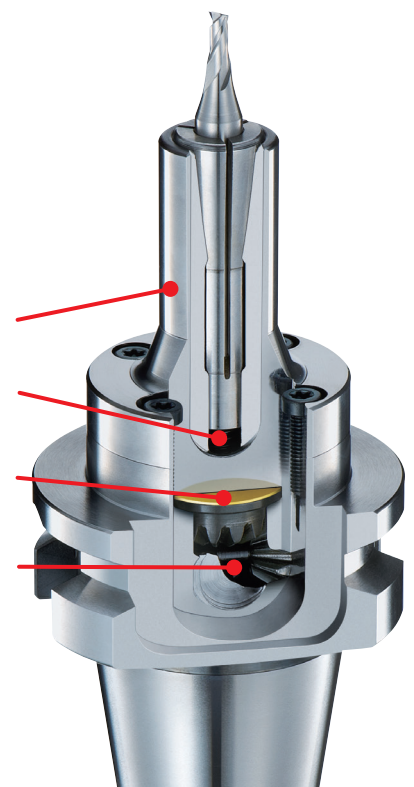

**For cutting tools with internal cooling**

**For cutting tools without internal cooling (drills/milling cutters)**

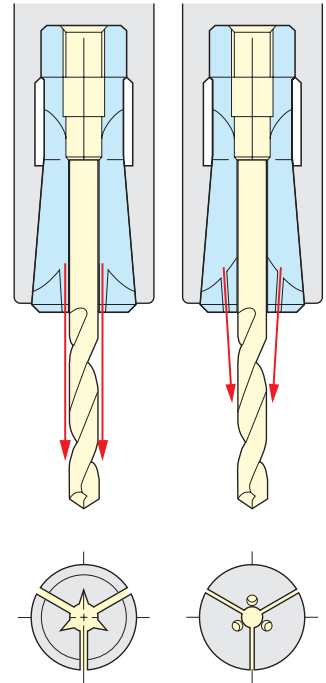
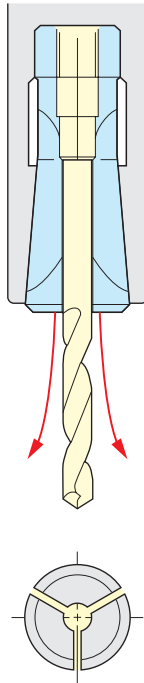
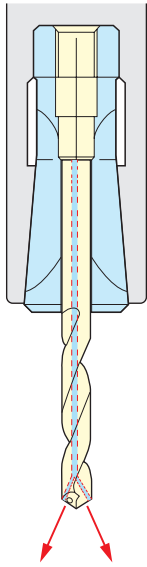

(VMK8-2J, 3J)

The VMK version is sealed and thus designed for cutting tools with internal cooling

PMK are Standard Collet

VMK-J collets have jet channels or jet holes for effective jet cooling

VMK-Collet

PMK-Collet (MMC8, 12)

VMK-J-Collet

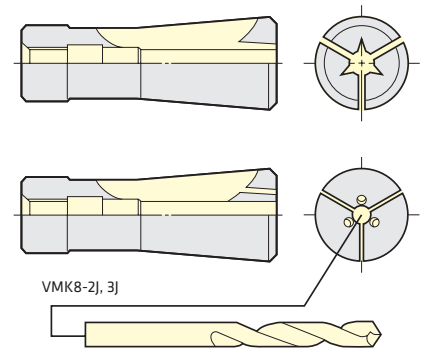
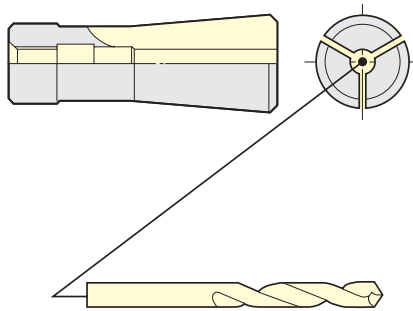
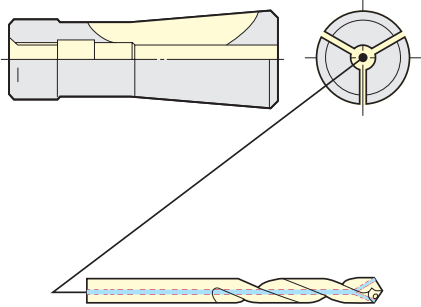

Cutting tool with internal cooling

Cutting tools without internal cooling (Standard)

Cutting tool without internal cooling

**MINI MINI COLLET**

**Mini Mini Collet**

**Version**

**Size**

PMK8-□

2/3/4/5/6/7/8

PMK12-□

4/5/6/8/10/12

VMK8-□

2/3/4/5/6/7/8

VMK8-□

2J/3J/4J/5J/6J/7J/8J



The NIKKEN Major Dream Holder is the optimal solution for vibration-damped milling. Through the revolutionary micro-damping system, the system is ideally suited for HSC and HPC milling.

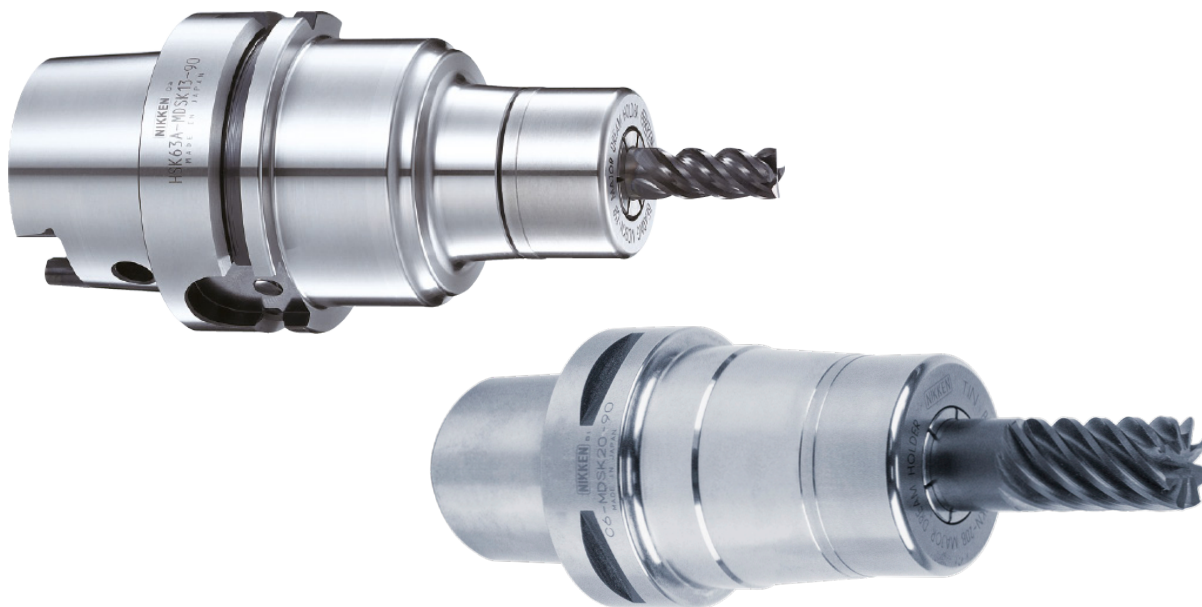

## PROPERTIES

- Concentricity guarantee 3 μm at 4 × diameter
- TiN bearing washer
- Unique internal design provides "built-in" damping and anti-vibration
- 8° collet system
- High speed options up to 30,000 rpm at G2.5 available
- Jet & Ikz available
- Clamping Range: ø3-25.4mm

## RUNOUT OF COLLET (SK)

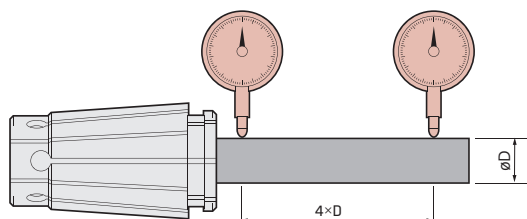

Collet Type	Max. Concentricity	
	At the Collet	At 4×D
A/AC	1 μ	3 μ

## MAJOR DREAM SYSTEM

- Stable high precision
- Simple design without grooves
- TiN bearing washer (HV2,200)
- 8° Collet with higher stiffness for better accuracy and higher clamping force
- Special coating ensures high efficiency

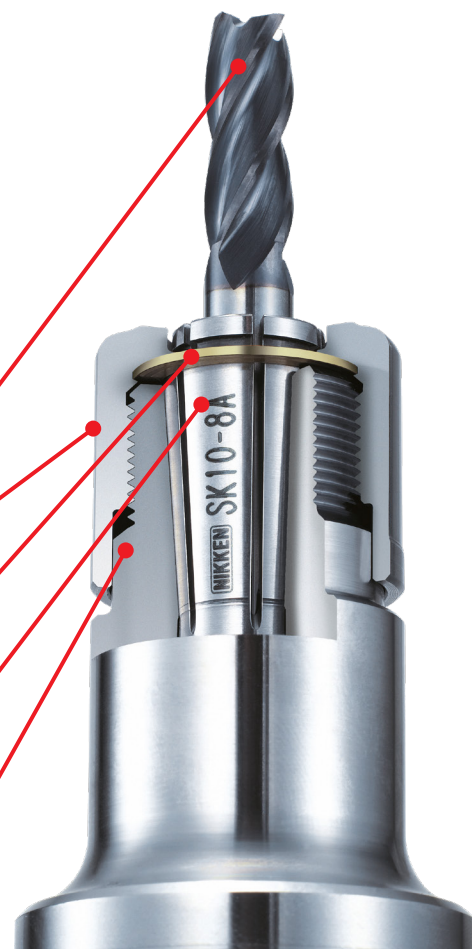

The Mutli-Lock Milling Chuck is without question an efficient and variable milling solution to meet the requirements of many different applications. The power chuck can be used as a superior basic holder, through our extensive selection of reducing sleeves, but also for applications with a wide variety of tool diameters and without much loss of clamping force.

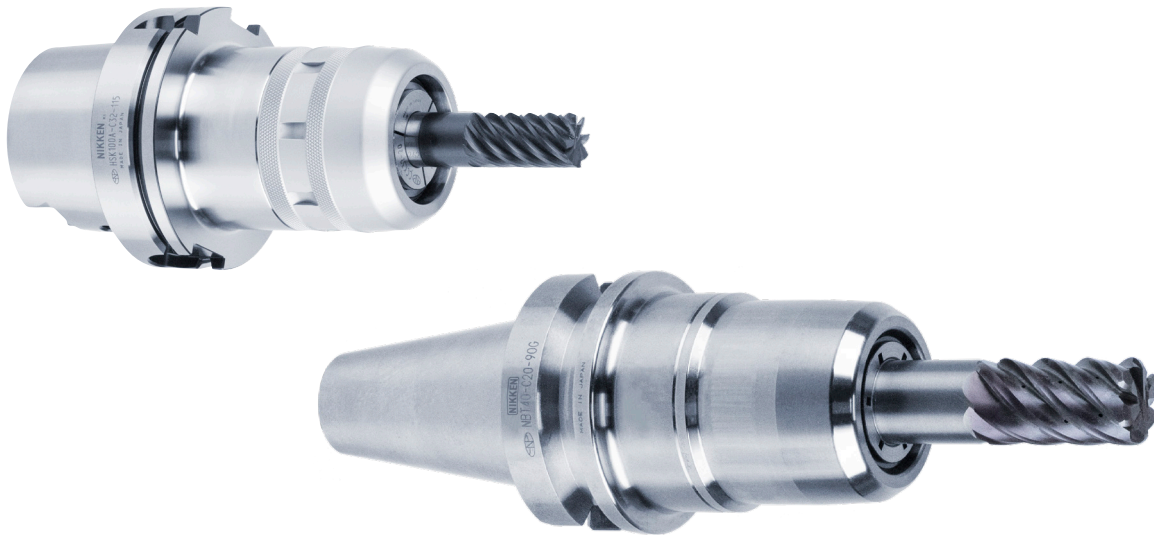

## PROPERTIES

- High accuracy and stability
- Highest clamping forces
- Clamping over the entire cutter shank
- No axial play
- Perfect as a basic holder
- Jet & Ikz available
- Clamping Range:  $\varnothing$  2-42mm

## CONCENTRICITY OF THE CHUCK

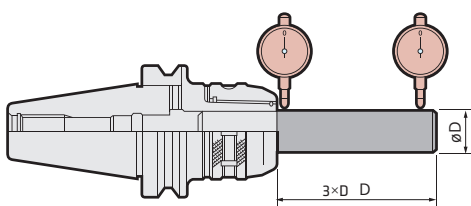

Max. Concentricity	
At the Collet	At 3×D
1μ	5μ

## MULTI-LOCK MILLING CHUCK

Unique grooved bore for higher clamping forces

World-renowned multi-roller bearing system

Face contact on the clamping nut

Optimum stability and performance due to NIKKEN's innovative heat treatment

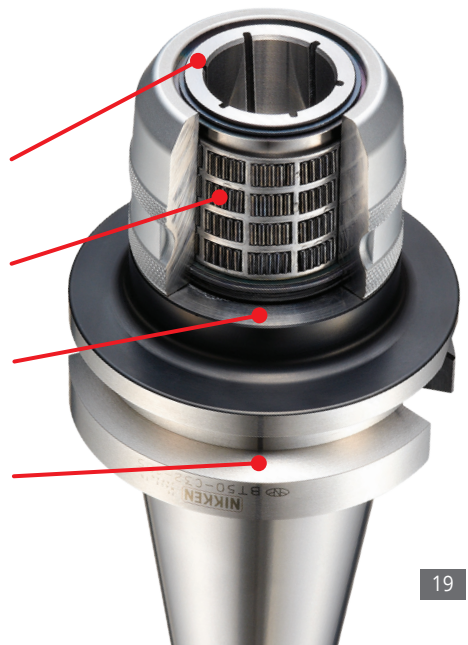

## MULTI-LOCK STRUCTURE (HIGH-SPEED VERSION)

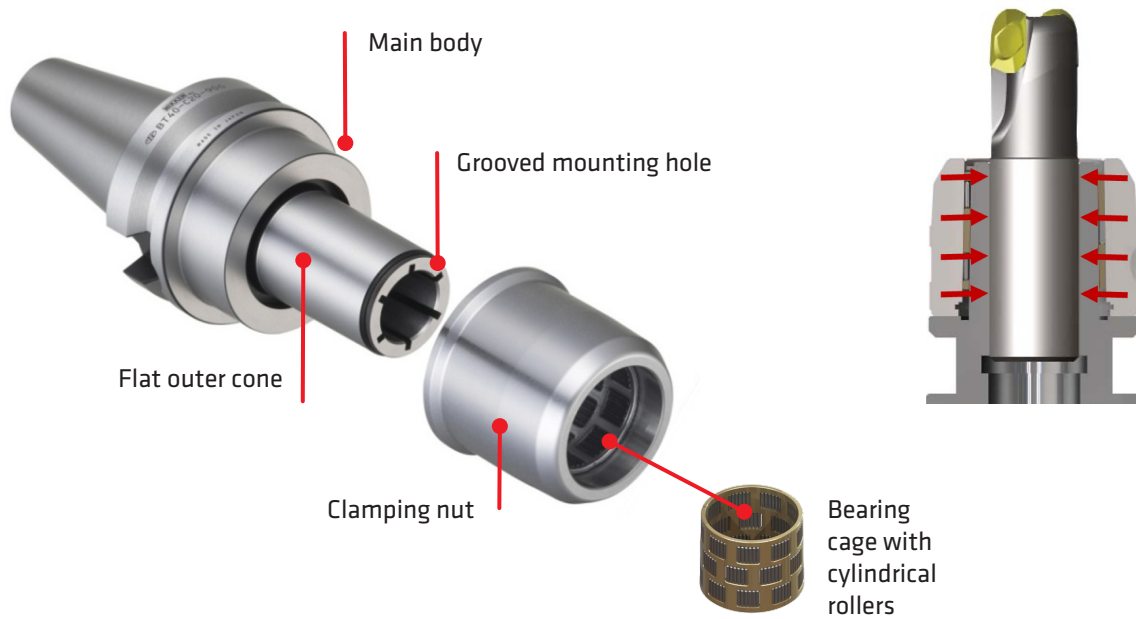

## CLAMPING FORCE COMPARISON

- NIKKEN Multi-Lock
- Competitor Hydroexpansion
- Competitor Shrink Fit Chuck
- Competitor Mechanical Chuck

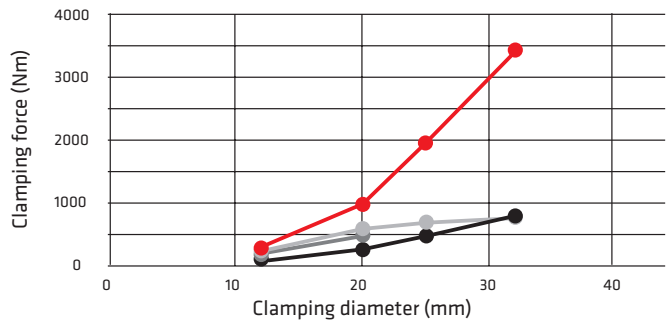

Standard Multi-Lock		
Size	∅ Clamping nut	∅ Clamping Range (with sleeves)
C20	52	2.0-20.0
C25	55/60	3.0-25.0
C32	64/69	3.0-32.0
C42	86	3.0-42.0

High Speed Multi-Lock		
Size	∅ Clamping nut	∅ Clamping Range (with sleeves)
C20G	48	2.0-20.0
C25G	55	3.0-25.0
C32G	68	3.0-32.0



Multi-Lock	Hook Spanner
C20	9HC22
C25 Ø55	9HC22
C25 Ø60	9HC25
C32 Ø64	9HC25
C32 Ø69	9HC32
C42	9HC42



High Speed Multi-Lock	Roller Key
C20-G	GH20
C25-G	GH25
C32-G Ø62	GH32S
C32-G Ø68	GH32

The Multi-Lock is most effective when clamped directly. However, a variety of options are available to extend the range of applications.



Thread for cover cap



Thread for cover cap

Designation	Property
KM	Standard reducing sleeve (z. B.: KM20-12)
NK	Reducing sleeve with length adjustment (z. B.: NK20-12)
CCK	Reducing sleeve with thread for optional cover caps - can also be used without cover cap (z. B.: CCK20-10 with cover cap CKFN20-12 oder CKFN20-12C)
CCNK	Reducing sleeve with thread for optional cover caps - with length adjustment (z. B.: CCNK20-12 with cover cap CKFN20-12 oder CKFN20-12C)



## Cutting tool with internal cooling (drill, milling cutter)

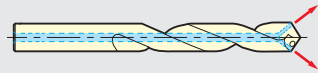

Direct clamping \*

with clamping sleeve

## Jet cooling

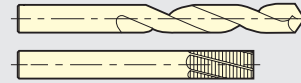

Direct clamping \*

with clamping sleeve

Cover ring with O-ring for direct clamping



CKFN-DC

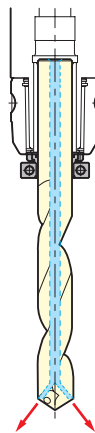

Cover ring with jet for direct clamping



CKFN-D  
(with jet channels)

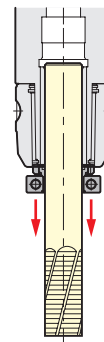

Cover plates for jet cooling



CCNK  
Collet



CCK  
Collet



CKFN-MN  
(with cooling  
nozzles)



CKFN  
(with  
V-channels)

Cover plates  
with O-Ring



CCNK  
Collet



CCK  
Collet



CKFN-C

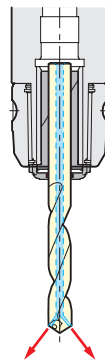

Cover ring for direct clamping with jet cooling - if the clamping length of the cutting tool is shorter than  $\ell_1$ .



CKFN-D  
(with jet channels)

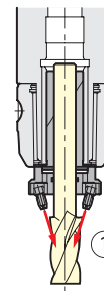
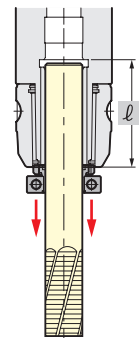

①

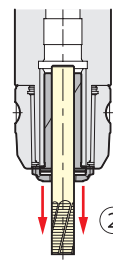

②

① The cutting diameter is bigger than the shaft diameter

② Cover plate with jet channels

Multi-Lock  
Standard  
BT□□-C□□

Multi-Lock in  
version C: e.g.  
IT□□-C□□C  
BT□□-C□□C  
MBT□□-C□□  
NBT□□-C□□  
HSK□□-C□□

- ① If the cutter is shorter than  $\ell_1$ , a stopper is recommended.
- ② If the cutter tool is longer than  $\ell_1$ , no accessories are needed.

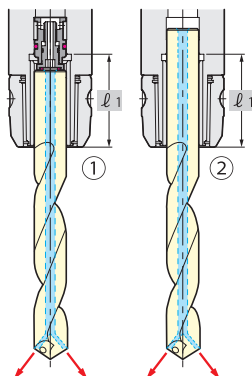

\* Direct clamping: when a Multi-Lock C32 is clamped into a cutting tool with D32.

\* A sealed adjusting screw is recommended for high pressure cooling.

## KM COLLET

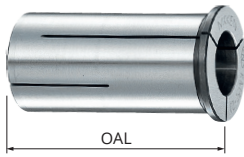

Pictured: Anniversary type KM clamping sleeve

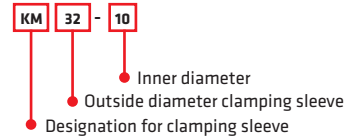

Size	OAL	KM clamping sleeve - Designation
<b>KM20</b>	53	KM20-2, 3, 4, 5, 6, 8, 10, <b>12</b> , 16
<b>KM25</b>	59	KM25-3, 4, 5, 6, 7, 8, 9, 10, 11, <b>12</b> , 13, <b>14</b> , <b>15</b> , <b>16</b> , 17, <b>18</b> , <b>19</b> , <b>20</b> , 21, 22
<b>KM32</b>	64.5	KM32-3, 4, 5, 6, 8, 10, <b>12</b> , <b>16</b> , <b>20</b> , <b>22</b> , <b>25</b> , 30

Number in red means with grooves in the bore, Anniversary design, Q at the end of the designation, optimised slots

- Other sizes in inches or inches are available
- Shaft tolerance h6 to h7 recommended
- ( ) OAL Mass for KM42-12 and Sizer
- Clamping sleeve outlier is optionally available (9CKR)

## NK CLAMPING SLEEVE

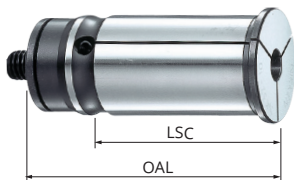

The length can be adjusted from the front and from behind

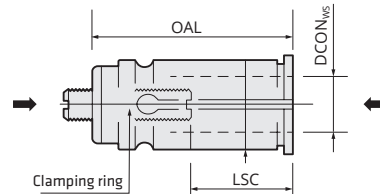

Adjustment possible from both sides

Size	OAL	LSC	NK clamping sleeve - Designation
<b>NK20</b>	63	20-40	NK20-3, 4, 5, 6, 8, 10, <b>12</b> , 16
<b>NK25</b>	68	30-55	NK25-3, 4, 5, 6, 8, 10, <b>12</b> , <b>16</b> , <b>20</b> , 22
<b>NK32</b>	75	30-60	NK32-3, 4, 5, 6, 8, 10, <b>12</b> , <b>16</b> , <b>20</b> , 22, <b>25</b>

Number in red means with grooves in the bore, Anniversary design, Q at the end of the designation, optimised slots

- Other sizes in inches are available
- Shaft tolerance h6 to h7 recommended
- ( ) OAL Mass for KM42-12 and Sizer
- Clamping sleeve outlier is optionally available (9CKR)



## CCK CLAMPING SLEEVE

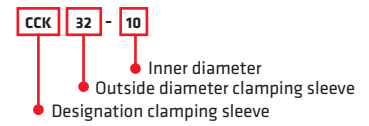
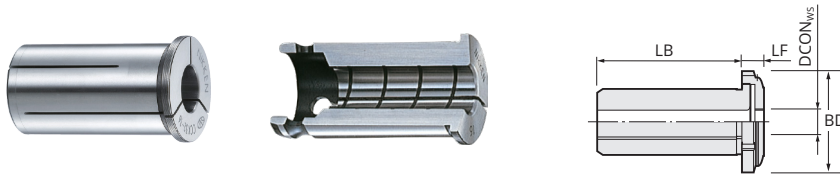

Size	DCON <sub>Ms</sub>	BD	LB	LF	CCK Clamping Sleeve - Designation	Cover Cap
<b>CCK20</b>	20	33	50.5	8	CCK20-6, 8, 10, <b>12</b> , 16	CKFN20
<b>CCK25</b>	25	39	56	8.5	CCK25-6, 8, 10, <b>12</b> , <b>16</b> , <b>20</b>	CKFN25
<b>CCK32</b>	32	46.5, 43	61.5	9	CCK32-6, 8, 10, <b>12</b> , <b>16</b> , <b>20</b> , <b>25</b>	CKFN32, CKFN32T

Number in red means with grooves in the bore, Anniversary design, Q at the end of the designation, optimised slots

- Shaft tolerance h6 to h7 recommended
- Other sizes in inches are available
- Cover caps and the key for them are optional
- Clamping sleeve outlier is optionally available (9CKR)
- Can also be used without cover cap as standard adapter sleeve

## CCNK CLAMPING SLEEVE



Photo shows clamping sleeve with cover cap

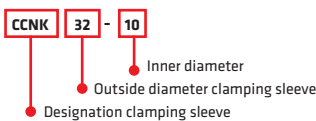

Size	CCK Clamping Sleeve - Designation	Cover Cap
<b>CCNK20</b>	CCNK20-6, 8, 10, <b>12</b> , <b>16</b>	CKFN20
<b>CCNK25</b>	CCNK25-6, 8, 10, <b>12</b> , <b>16</b> , <b>20</b>	CKFN25
<b>CCNK32</b>	CCNK32-6, 8, 10, <b>12</b> , <b>16</b> , <b>20</b> , <b>25</b>	CKFN32, CKFN32T

Number in red means with grooves in the bore, Anniversary design, Q at the end of the designation, optimised slots

- Shaft tolerance h6 to h7 recommended
- Other sizes in inches are available
- Cover caps and the key for them are optional
- Clamping sleeve outlier is optionally available (9CKR)
- Length adjustment is possible from the front and from the back
- Can also be used without cover cap as standard adapter sleeve

## COVER CAPS

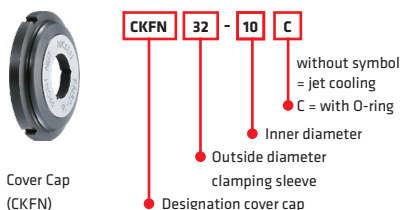

Cover Cap (CKFN)

Size	BD	LF	Cover Cap	Key
<b>CKFN20</b>	33	8	CKFN20-6, 8, 10, 12, 16	CCKL20
<b>CKFN25</b>	39	8.5	CKFN25-6, 8, 10, 12, 16, 20	CCKL25
<b>CKFN32</b>	46.5	9	CKFN32-6, 8, 10, 12, 16, 20, 25	CCKL32
<b>CKFN32T</b>	43	9	CKFN32T-6, 8, 10, 12, 16, 20, 25	CCKL25

- Two sizes are available for C32: Outer diameter 69mm = CKFN32 for outer diameter 64mm = CKFN32T
- Other sizes in inches are available

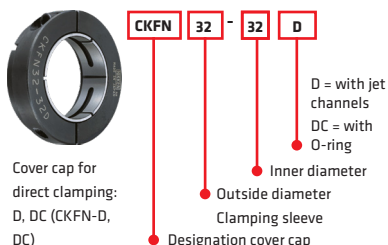

Cover cap for direct clamping: D, DC (CKFN-D, DC)

Size	Cover cap for direct clamping	Key
<b>CKFN20</b>	CKFN20-20D, 20DC	CCKL20
<b>CKFN25</b>	CKFN25-25D, 25DC	CCKL25
<b>CKFN32</b>	CKFN32-32D, 32DC	CCKL32
<b>CKFN32T</b>	CKFN32T-32D, 32DC	CCKL25

- Two sizes are available for C32: Outer diameter 69mm = CKFN32 for outer diameter 64mm = CKFN32T

When a machine has been in operation for 2-3 years, the concentricity of the spindle may deteriorate. The NIKKEN Zero Fit Holder allows to compensate this spindle error at least to the delivery condition.

A common spindle runout is about 21  $\mu\text{m}$  - if this value can be reduced to 3  $\mu\text{m}$ , the tool life increases. If this value can be reduced to 3  $\mu\text{m}$ , the tool life increases by a factor of 5.

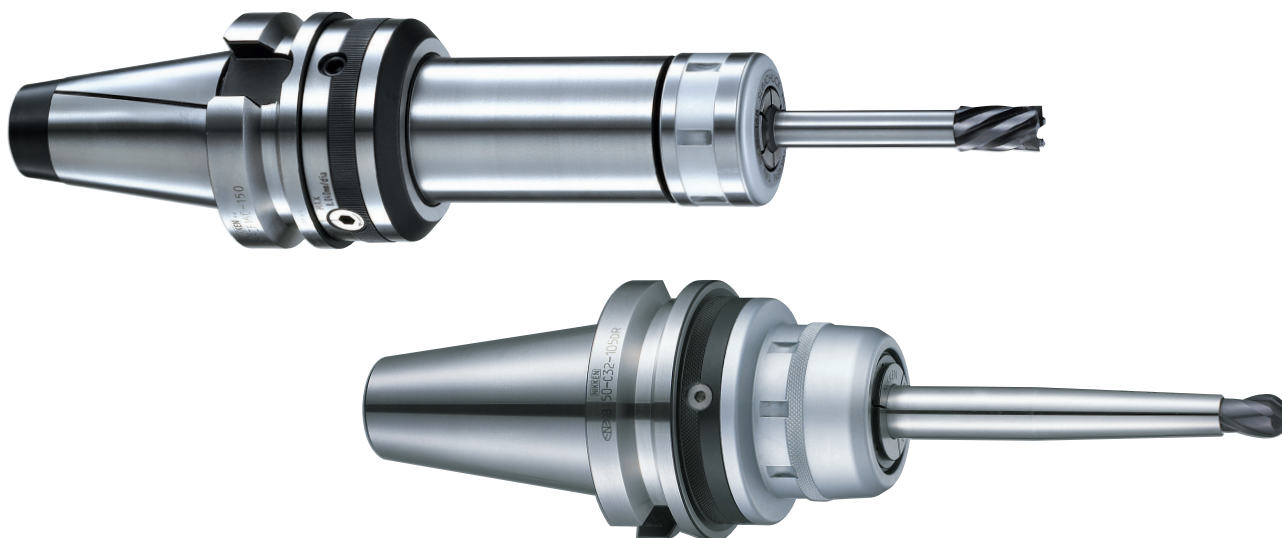

## PROPERTIES

- 2 variants: Slim Chuck (SZF) and Multi-Lock (CZF)
- Easy adjustment via cam and locking system
- Available with one cam or as a new multiple cam system
- Easy adjustment for long tools
- Jet & Ikz available
- Clamping Range SZF:  $\varnothing$  0.7-25.4mm
- Clamping Range CZF:  $\varnothing$  2-42mm

### MULTIPLE CAM - ADJUSTMENT SYSTEM

- Double screw lock
- Balanced adjustment ring
- Cam fine adjustment
- Main cam







Adjustment range at 100mm extension length.  
At 200mm the range is twice as high.

SZF6	0.050mm
SZF10	0.050mm
SZF16	0.040mm
SZF25	0.025mm
CZF20	0.050mm
CZF25	0.050mm
CZF32	0.030mm

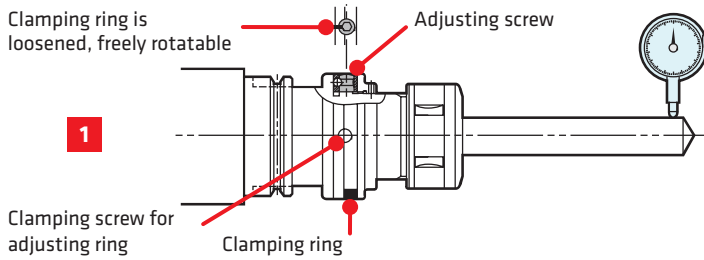

Loosen the screws on the adjusting ring until the clamping ring can rotate freely.

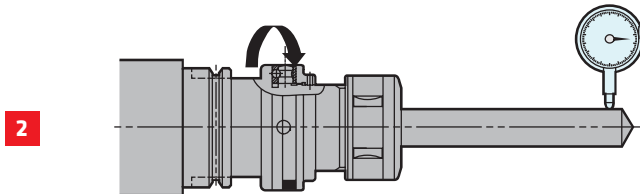

Set the dial gauge and find the highest runout. Hold at this position.

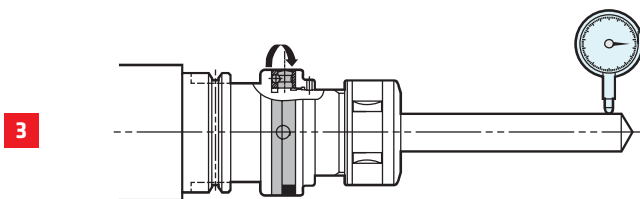

Turn the adjusting ring to the same position.

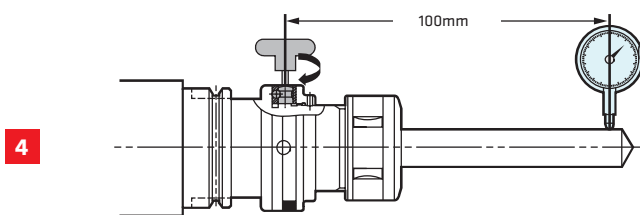

Use the eccentric screw on the adjusting ring to set the runout in the middle from the smallest to the highest runout.

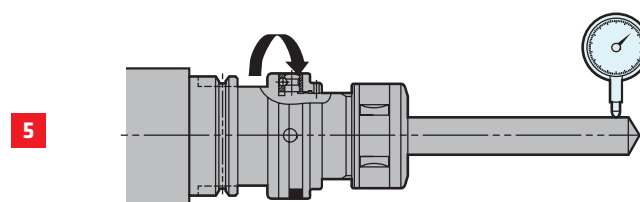

Check the concentricity, otherwise repeat from step 2. As soon as the desired concentricity is achieved, tighten the clamping screws on the adjusting ring.

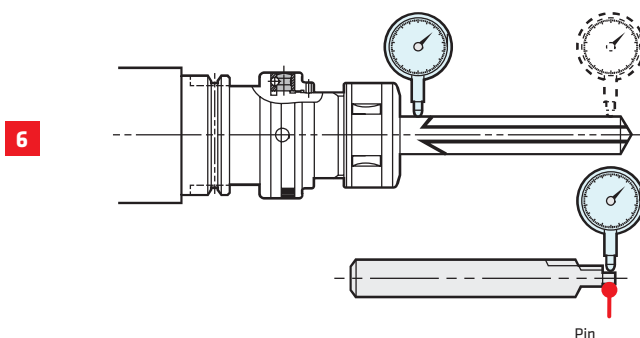

If it is impossible to set the dial gauge on the cutting edges, it is also possible to measure on the cylindrical part of the cutting tool. For special tools it is recommended to grind a setting aid (pivot).

# HSK DIN69893 Form A / E / F

SLIM CHUCK – HSK FORM A

Overview | Page 8 - 15



Form A

Designation	LF	Diameter	LSCN	LSCX	LB	LB1	BD	BD1	Max. rpm
HSK40A-SK6-60	60	0.7-6.0	40	40	37	-	19.5	-	15,000
HSK40A-SK6C-80	80	0.7-6.0	26-31	46	57	-	19.5	-	15,000
HSK40A-SK10-60	60	1.75-10.0	40	40	39	-	27.5	-	15,000
HSK40A-SK10-75	75	1.75-10.0	29-36	43	52	-	27.5	-	15,000
HSK40A-SK10C-100	100	1.75-10.0	33-41	58	77	-	27.5	-	15,000
HSK40A-SK16-80	80	2.75-16.0	60	60	59	-	40	-	10,000
HSK40A-SK16-120	120	2.75-16.0	45-52	77	99	-	40	-	10,000
HSK63A-SK6-60	60	0.7-6.0	38	38	31	-	19.5	-	15,000
HSK63A-SK6-80	80	0.7-6.0	21-35	58	51	-	19.5	-	15,000
HSK63A-SK6C-□	100, 120, 150	0.7-6.0	26-35	46	62, 62, 60	71, 91, 121	19.5	32, 32, 25	15,000
HSK63A-SK10-60	60	1.75-10.0	35	35	31	-	27.5	-	15,000
HSK63A-SK10C-□	90, 105, 120	1.75-10.0	33-41	53, 58, 58, 58, 58	59, 74, 60, 75, 73	59, 74, 91, 106, 121	27.5	27.5, 27.5, 32, 40, 34.5	15,000
HSK63A-SK16-80	80	2.75-16.0	52	52	51	-	40	-	10,000
HSK63A-SK16-105	105	2.75-16.0	50-58	65	76	-	40	-	10,000
HSK63A-SK16C-120	120	2.75-16.0	45-52	77	91	-	40	-	10,000
HSK63A-SK16C-150	150	2.75-16.0	45-57	84	121	-	40	-	10,000
HSK63A-SK20-90	90	3.5-20.0	59	59	63	-	48.5	-	12,000
HSK63A-SK20-105	105	3.5-20.0	50-57	64	78	-	48.5	-	12,000
HSK63A-SK20C-□	120, 135	3.5-20.0	50-55	74	93, 108	-	48.5	-	12,000
HSK100A-SK10C-□	105, 120	1.75-10.0	33-41	58	57, 74	71, 86	27.5	40	15,000
HSK100A-SK10C-150	150	1.75-10.0	33-41	58	80, 75	116, 166	27.5	40, 39	12,000
HSK100A-SK16-105	105	2.75-16.0	45-60	63	71	-	40	-	15,000
HSK100A-SK16C-120	120	2.75-16.0	45-52	77	86	-	40	-	15,000
HSK100A-SK16C-150	150	2.75-16.0	45-52	84	90	116	40	50	15,000
HSK100A-SK20C-120	120	3.5-20.0	50-55	74	86	-	48.5	-	12,000
HSK100A-SK20C-150	150	3.5-20.0	47-63	82	116	-	48.5	-	12,000

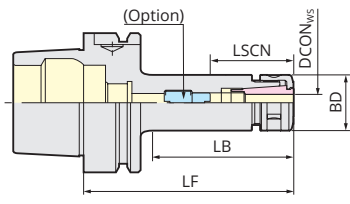

Fig. 1

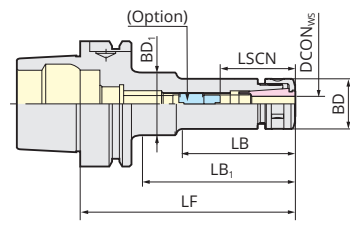

Fig. 2

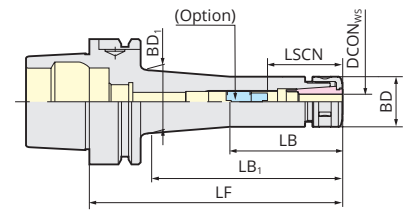

Fig. 3

Clamping Key	Collet	Stop Screw	TiN Clamping Nut (Standard)	Jet Type Clamping Nut	Jet Cover Cap	O-ring Cover Cap	Cover Cap Spanner	Fig.
SKL-6W	SK6-□	-	SKN-6WK	SKN-6WKJ	SKJ6-□	SKJ6-□C	SKJL-6	1
SKL-6W	SK6-□	SKG6-6HG	SKN-6WK	SKN-6WKJ	SKJ6-□	SKJ6-□C	SKJL-6	1
SKL-10	SK10-□	-	SKN-10K	SKN-10KJ	SKJ10-□	SKJ10-□C	SKJL-10	1
SKL-10	SK10-□	SKG10-10HG	SKN-10K	SKN-10KJ	SKJ10-□	SKJ10-□C	SKJL-10	1
SKL-10	SK10-□	SKG10-10HG	SKN-10K	SKN-10KJ	SKJ10-□	SKJ10-□C	SKJL-10	1
9HC16	SK16-□	-	SKN-16B	SKN-16BJ	SKJ16-□	SKJ16-□C	SKJL-16	1
9HC16	SK16-□	SKG16-10HG	SKN-16B	SKN-16BJ	SKJ16-□	SKJ16-□C	SKJL-16	1
SKL-6W	SK6-□	-	SKN-6WK	SKN-6WKJ	SKJ6-□	SKJ6-□C	SKJL-6	1
SKL-6W	SK6-□	SKG6-6HG	SKN-6WK	SKN-6WKJ	SKJ6-□	SKJ6-□C	SKJL-6	1
SKL-6W	SK6-□	SKG6-6HG	SKN-6WK	SKN-6WKJ	SKJ6-□	SKJ6-□C	SKJL-6	2, 2, 3
SKL-10	SK10-□	-	SKN-10K	SKN-10KJ	SKJ10-□	SKJ10-□C	SKJL-10	1
SKL-10	SK10-□	SKG10-10HG	SKN-10K	SKN-10KJ	SKJ10-□	SKJ10-□C	SKJL-10	1, 1, 2, 2, 3
9HC16	SK16-□	-	SKN-16B	SKN-16BJ	SKJ16-□	SKJ16-□C	SKJL-16	1
9HC16	SK16-□	SKG16-10HG	SKN-16B	SKN-16BJ	SKJ16-□	SKJ16-□C	SKJL-16	1
9HC16	SK16-□	SKG16-10HG	SKN-16B	SKN-16BJ	SKJ16-□	SKJ16-□C	SKJL-16	1
9HC16	SK16-□	SKG16-10HG	SKN-16B	SKN-16BJ	SKJ16-□	SKJ16-□C	SKJL-16	1
9HC22	SK20-□	-	SKN-20B	SKN-20BJ	SKJ25-□	SKJ25-□C	SKJL-25	1
9HC22	SK20-□	SKG20-12MFHG	SKN-20B	SKN-20BJ	SKJ25-□	SKJ25-□C	SKJL-25	1
9HC22	SK20-□	SKG20-12MFHG	SKN-20B	SKN-20BJ	SKJ25-□	SKJ25-□C	SKJL-25	1
SKL-10	SK10-□	SKG10-10HG	SKN-10K	SKN-10KJ	SKJ10-□	SKJ10-□C	SKJL-10	2
SKL-10	SK10-□	SKG10-10HG	SKN-10K	SKN-10KJ	SKJ10-□	SKJ10-□C	SKJL-10	2
9HC16	SK16-□	SKG16-12HG	SKN-16B	SKN-16BJ	SKJ16-□	SKJ16-□C	SKJL-16	1
9HC16	SK16-□	SKG16-12HG	SKN-16B	SKN-16BJ	SKJ16-□	SKJ16-□C	SKJL-16	1
9HC16	SK16-□	SKG16-12HG	SKN-16B	SKN-16BJ	SKJ16-□	SKJ16-□C	SKJL-16	2
9HC22	SK20-□	SKG20-12MFHG	SKN-20B	SKN-20BJ	SKJ25-□	SKJ25-□C	SKJL-25	1
9HC22	SK20-□	SKG20-12HG	SKN-20B	SKN-20BJ	SKJ25-□	SKJ25-□C	SKJL-25	1



# HSK DIN69893 Form A / E / F

## SLIM CHUCK HIGH SPEED – HSK FORM A

Overview | Page 8 - 15



Form A

Designation	LF	Diameter	LSCN	LSCX	LB	LB1	BD	BD1	Max. rpm
HSK40A-SK6-60P	60P	0.7-6.0	40	40	37	-	19.5	-	40,000
HSK40A-SK10-75P	75P	1.75-10.0	29-36	43	52	-	27.5	-	40,000
HSK40A-SK16-80P	80P	2.75-16.0	60	60	59	-	40	-	30,000
HSK50A-SK6-60P	60P	0.7-6.0	37	37	31	-	19.5	-	30,000
HSK63A-SK6-□	60P, 80P	0.7-6.0	38	38, 58	31, 51	-	19.5	-	30,000
HSK63A-SK6C-□	100P, 120P	0.7-6.0	26-31	46	62	71, 91	19.5	32	30,000
HSK63A-SK10-60P	60P	1.75-10.0	35	35	31	-	27.5	-	30,000
HSK63A-SK10C-90P	90P	1.75-10.0	33-36	53	53	-	27.5	-	30,000
HSK63A-SK10C-□	105P, 120P	1.75-10.0	33-41	58	74, 60	74, 91	27.5	27.5, 32	30,000
HSK63A-SK16-80P	80P	2.75-16.0	52	52	51	-	40	-	25,000
HSK63A-SK16-105P	105P	2.75-16.0	50-58	65	76	-	40	-	25,000
HSK63A-SK16C-120P	120P	2.75-16.0	45-52	77	91	-	40	-	25,000
HSK63A-SK20-90P	90P	3.5-20.0	59	59	63	-	48.5	-	25,000
HSK63A-SK20-105P	105P	3.5-20.0	50-57	64	78	-	48.5	-	25,000
HSK63A-SK20C-□	120P, 135P	3.5-20.0	50-55	74	93, 108	-	48.5	-	25,000
HSK100A-SK10C-□	105P, 120P	1.75-10.0	33-41	58	57, 74	71, 86	27.5	40	20,000
HSK100A-SK10C-150P	150P	1.75-10.0	33-41	58	80	116	27.5	40	20,000
HSK100A-SK16-105P	105P	2.75-16.0	45-60	63	71	-	40	-	20,000
HSK100A-SK16C-120P	120P	2.75-16.0	45-52	77	86	-	40	-	20,000
HSK100A-SK16C-150P	150P	2.75-16.0	45-52	84	90	116	40	50	20,000
HSK100A-SK20C-120P	120P	3.5-20.0	50-55	74	86	-	48.5	-	20,000
HSK100A-SK20C-150P	150P	3.5-20.0	47-63	82	116	-	48.5	-	20,000

## SLIM CHUCK HIGH SPEED – HSK FORM E / F

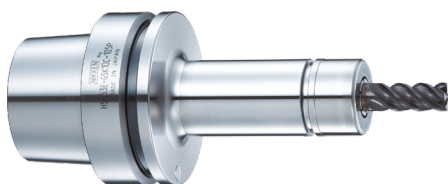

Form E

Designation	LF	Diameter	LSCN	LSCX	LB	LB1	BD	BD1	Max. rpm
HSK25E-SK6-45P	45P	0.7-6.0	30.5	30.5	35	-	19.5	-	50,000
HSK25E-SK10-55P	55P	1.75-10.0	41	41	35	-	27.5	-	40,000
HSK32E-SK6-50P	50P	0.7-6.0	30.5	32	29	-	19.5	-	50,000
HSK32E-SK10-□	60P, 75P	1.75-10.0	44.29-36	44, 43	41, 54	-	27.5	-	40,000
HSK40E-SK6-60P	60P	0.7-6.0	40	40	37	-	19.5	-	40,000
HSK40E-SK10-□	60P, 75P	1.75-10.0	29-36	40, 43	39, 54	-	27.5	-	40,000
HSK40E-SK16-80P	80P	2.75-16.0	60	59	59	-	40	-	30,000

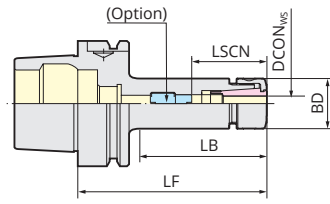

Fig. 1

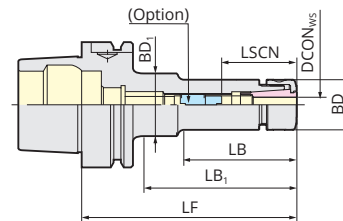

Fig. 2

Roller Key	Collet	Stop Screw	TiN Clamping Nut (Standard)	Jet Type Clamping Nut	Jet Cover Cap	O-ring Cover Cap	Cover Cap Spanner	Fig.
GH6	SK6-□	-	SKN-6WK(GH)	SKN-6WKJ(GH)	SKJ6-□	SKJ6-□C	SKJL-6	1
GH10	SK10-□	SKG10-10HG	SKN-10K(GH)	SKN-10KJ(GH)	SKJ10-□	SKJ10-□C	SKJL-10	1
GH16	SK16-□	-	SKN-16B(GH)	SKN-16BJ(GH)	SKJ16-□	SKJ16-□C	SKJL-16	1
GH6	SK6-□	-	SKN-6WK(GH)	SKN-6WKJ(GH)	SKJ6-□	SKJ6-□C	SKJL-6	1
GH6	SK6-□	-	SKN-6WK(GH)	SKN-6WKJ(GH)	SKJ6-□	SKJ6-□C	SKJL-6	1
GH6	SK6-□	SKG6-6HG	SKN-6WK(GH)	SKN-6WKJ(GH)	SKJ6-□	SKJ6-□C	SKJL-6	2
GH10	SK10-□	-	SKN-10K(GH)	SKN-10KJ(GH)	SKJ10-□	SKJ10-□C	SKJL-10	1
GH10	SK10-□	SKG10-10HG	SKN-10K(GH)	SKN-10KJ(GH)	SKJ10-□	SKJ10-□C	SKJL-10	1
GH10	SK10-□	SKG10-10HG	SKN-10K(GH)	SKN-10KJ(GH)	SKJ10-□	SKJ10-□C	SKJL-10	1, 2
GH16	SK16-□	-	SKN-16B(GH)	SKN-16BJ(GH)	SKJ16-□	SKJ16-□C	SKJL-16	1
GH16	SK16-□	SKG16-10HG	SKN-16B(GH)	SKN-16BJ(GH)	SKJ16-□	SKJ16-□C	SKJL-16	1
GH16	SK16-□	SKG16-10HG	SKN-16B(GH)	SKN-16BJ(GH)	SKJ16-□	SKJ16-□C	SKJL-16	1
GH16	SK16-□	SKG16-12HG	SKN-16B(GH)	SKN-16BJ(GH)	SKJ16-□	SKJ16-□C	SKJL-16	1
GH16	SK16-□	SKG16-12HG	SKN-16B(GH)	SKN-16BJ(GH)	SKJ16-□	SKJ16-□C	SKJL-16	2
GH16	SK16-□	SKG16-12HG	SKN-16B(GH)	SKN-16BJ(GH)	SKJ16-□	SKJ16-□C	SKJL-16	2
GH20	SK20-□	-	SKN-20B(GH)	SKN-20BJ(GH)	SKJ25-□	SKJ25-□C	SKJL-25	1
GH20	SK20-□	SKG20-12MFHG	SKN-20B(GH)	SKN-20BJ(GH)	SKJ25-□	SKJ25-□C	SKJL-25	1
GH20	SK20-□	SKG20-12MFHG	SKN-20B(GH)	SKN-20BJ(GH)	SKJ25-□	SKJ25-□C	SKJL-25	1
GH10	SK10-□	SKG10-10HG	SKN-10K(GH)	SKN-10KJ(GH)	SKJ10-□	SKJ10-□C	SKJL-10	2
GH10	SK10-□	SKG10-10HG	SKN-10K(GH)	SKN-10KJ(GH)	SKJ10-□	SKJ10-□C	SKJL-10	2
GH16	SK16-□	SKG16-12HG	SKN-16B(GH)	SKN-16BJ(GH)	SKJ16-□	SKJ16-□C	SKJL-16	1
GH16	SK16-□	SKG16-12HG	SKN-16B(GH)	SKN-16BJ(GH)	SKJ16-□	SKJ16-□C	SKJL-16	1
GH16	SK16-□	SKG16-12HG	SKN-16B(GH)	SKN-16BJ(GH)	SKJ16-□	SKJ16-□C	SKJL-16	2
GH20	SK20-□	SKG20-12MFHG	SKN-20B(GH)	SKN-20BJ(GH)	SKJ25-□	SKJ25-□C	SKJL-25	1
GH20	SK20-□	SKG20-12HG	SKN-20B(GH)	SKN-20BJ(GH)	SKJ25-□	SKJ25-□C	SKJL-25	1

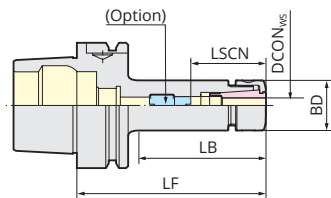

Fig. 1

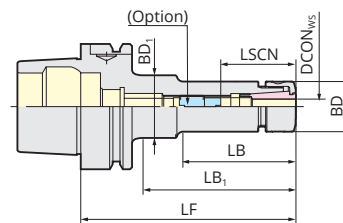

Fig. 2

Roller Key	Collet	Stop Screw	TiN Clamping Nut (Standard)	Jet Type Clamping Nut	Jet Cover Cap	O-ring Cover Cap	Cover Cap Spanner	Fig.
GH6	±	-	SKN-6WK(GH)	SKN-6WKJ(GH)	SKJ6-□	SKJ6-□C	SKJL-6	1
GH10	SK10-□	-	SKN-10K(GH)	SKN-10KJ(GH)	SKJ10-□	SKJ10-□C	SKJL-10	1
GH6	SK6-□	-	SKN-6WK(GH)	SKN-6WKJ(GH)	SKJ6-□	SKJ6-□C	SKJL-6	1
GH10	SK10-□	-	SKN-10K(GH)	SKN-10KJ(GH)	SKJ10-□	SKJ10-□C	SKJL-10	1
GH6	SK6-□	-	SKN-6WK(GH)	SKN-6WKJ(GH)	SKJ6-□	SKJ6-□C	SKJL-6	1
GH10	SK10-□	SKG10-10HG	SKN-10K(GH)	SKN-10KJ(GH)	SKJ10-□	SKJ10-□C	SKJL-10	1
GH16	SK16-□	-	SKN-16B(GH)	SKN-16BJ(GH)	SKJ16-□	SKJ16-□C	SKJL-16	1

# HSK DIN69893 Form A / E / F

MINI MINI CHUCK - HSK FORM A / E / F

Overview | Page 8 - 15

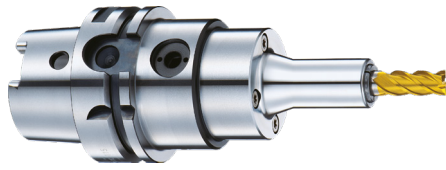

Form A - Model AT

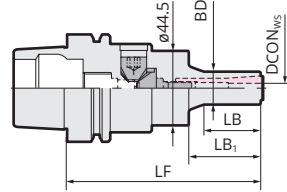

Designation	LF	Diameter	LSCN	LB	LB1	BD
HSK63A-MMC8C-□-AA	115, 145, 175	2.0-8.0	9.4-15.0	33, 40, 40	-	20
HSK63A-MMC8C-□	107-AT, 135-AT	2.0-8.0	9.4-15.0	36, 64	78, 106	20
HSK63A-MMC12C-□-AA	117, 147	4.0-12.0	20.0-31.0	35, 60, 70	-	30
HSK63A-MMC12C-□	110-AT, 135-AT	4.0-12.0	20.0-31.0	43, 68	83, 108	30
HSK100A-MMC8C-□-AA	130, 160	2.0-8.0	9.4-15.0	33, 40, 40	-	20
HSK100A-MMC8C-□	117-AT, 145-AT	2.0-8.0	9.4-15.0	36, 64	85, 113	20
HSK100A-MMC12C-□-AA	130, 160	4.0-12.0	20.0-31.0	35, 60, 70	-	30
HSK100A-MMC12C-□	120-AT, 145-AT	4.0-12.0	20.0-31.0	43, 63	90, 115	30

# HSK DIN69893 Form A / E / F

MAJOR DREAM HOLDER - HSK FORM A

Overview | Page 18

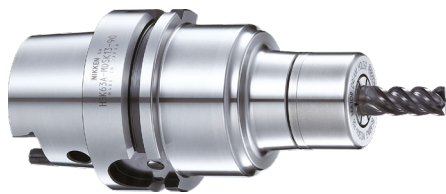

Form A

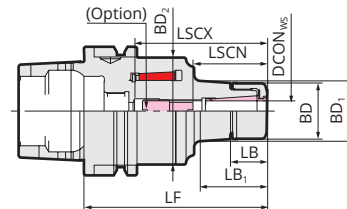

Designation	LF	Diameter	LSCN	LSCX	LB	LB1	BD	BD1	BD2
HSK63A-MDSK6-75	75	3.0-6.0	21-28	50	16.2	18	19.5	-	54.2
HSK63A-MDSK6-□	90, 105, 120	3.0-6.0	21-35	65, 80, 95	16.2	33, 48, 63	19.5	21.9, 24, 26.1	54.2
HSK63A-MDSK10-105	105	3.0-10.0	31-50	79	18.2	48	27.5	31.7	54.2
HSK63A-MDSK10-□	120, 135	3.0-10.0	30-50	94, 109	18.2	63, 79	27.5	33.8, 36	54.2
HSK63A-MDSK16-80	80	3.0-16.0	54	54	23	24	40	40	54.2
HSK63A-MDSK16-90	90	3.0-16.0	64	64	23	34.2	40	41.6	54.2
HSK63A-MDSK16-□	105, 120	3.0-16.0	45-60	79	23	49.3, 64.3	40	43.7, 45.8	54.2
HSK63A-MDSK16-135	135	3.0-16.0	45-60	85	23	79	40	47.9	54.2
HSK63A-MDSK20-90	90	4.0-20.0	64	105	25.2	40.9	48	51.2	54.2
HSK63A-MDSK20-105	105	4.0-20.0	79	64	25.2	54.3	48	51.1	54.2
HSK63A-MDSK20-□	120, 135	4.0-20.0	47-70	79	25.2	70, 85.8	48	50.6, 51.2	54.2
HSK100A-MDSK10-□	110, 125, 140, 165	3.0-10.0	30-50	80, 95, 110, 135	18.2	33, 48, 63, 89	27.5	29.8, 31.7, 33.8, 37.4	54
HSK100A-MDSK16-125	125	3.0-16.0	45-65	87	23	51	40	44	54
HSK100A-MDSK16-140	140	3.0-16.0	45-70	104	23	66	40	46.1	54
HSK100A-MDSK16-165	165	3.0-16.0	40-70	129	23	91	40	49.6	54
HSK100A-MDSK20-140	140	4.0-20.0	47-70	104	25.2	42	48	51.4	84
HSK100A-MDSK20-165	165	4.0-20.0	47-80	129	25.2	67	48	54.9	84



Form A - Model AA



Form E - Model AA

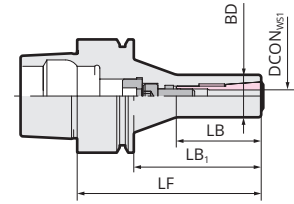

Max. rpm	Collet	Collet Metallic Sealing	Jet Collet
30,000	PMK8-□	VMK8-□	VMK8-□J
30,000	PMK8-□	VMK8-□	VMK8-□J
30,000	PMK12-□	VMK12-□	VMK12-□J
30,000	PMK12-□	VMK12-□	VMK12-□J
20,000	PMK8-□	VMK8-□	VMK8-□J
20,000	PMK8-□	VMK8-□	VMK8-□J
20,000	PMK12-□	VMK12-□	VMK12-□J
20,000	PMK12-□	VMK12-□	VMK12-□J

Max. rpm	Roller Key	Collet	Stop Screw	Jet Type Clamping Nut	Jet Cover Cap	O-ring Cover Cap	Cover Cap Spanner
20,000	GH6	SK6-□A	SKG-8	MDSKN-6KJ	SKJ6-□	SKJ6-□C	SKJL-6
20,000	GH6	SK6-□A	SKG-8	MDSKN-6KJ	SKJ6-□	SKJ6-□C	SKJL-6
20,000	GH10	SK10-□A	SKG-12S	MDSKN-10KJ	SKJ10-□	SKJ10-□C	SKJL-10
20,000	GH10	SK10-□A	SKG-12L	MDSKN-10KJ	SKJ10-□	SKJ10-□C	SKJL-10
20,000	GH16	SK16-□A	-	MDSKN-16BJ	SKJ16-□	SKJ16-□C	SKJL-16
20,000	GH16	SK16-□A	-	MDSKN-16BJ	SKJ16-□	SKJ16-□C	SKJL-16
20,000	GH16	SK16-□A	SKG-18S	MDSKN-16BJ	SKJ16-□	SKJ16-□C	SKJL-16
20,000	GH16	SK16-□A	SKG-18L	MDSKN-16BJ	SKJ16-□	SKJ16-□C	SKJL-16
20,000	GH20	SK20-□A	-	MDSKN-20BJ	SKJ25-□	SKJ25-□C	SKJL-25
20,000	GH20	SK20-□A	-	MDSKN-20BJ	SKJ25-□	SKJ25-□C	SKJL-25
20,000	GH20	SK20-□A	SKG20-22	MDSKN-20BJ	SKJ25-□	SKJ25-□C	SKJL-25
20,000	GH10	SK10-□A	SKG-12L	MDSKN-10KJ	SKJ10-□	SKJ10-□C	SKJL-10
20,000	GH16	SK16-□A	SKG-18S	MDSKN-16BJ	SKJ16-□	SKJ16-□C	SKJL-16
20,000	GH16	SK16-□A	SKG-18S	MDSKN-16BJ	SKJ16-□	SKJ16-□C	SKJL-16
20,000	GH16	SK16-□A	SKG-18L	MDSKN-16BJ	SKJ16-□	SKJ16-□C	SKJL-16
20,000	GH20	SK20-□A	SKG-22	MDSKN-20BJ	SKJ25-□	SKJ25-□C	SKJL-25
20,000	GH20	SK20-□A	SKG-22	MDSKN-20BJ	SKJ25-□	SKJ25-□C	SKJL-25

Optionally, all holders can be ordered in the "High Speed" version - Insert the designation "P" at the end

# HSK DIN69893 Form A / E / F

STANDARD MULTI-LOCK MILLING CHUCK – HSK FORM A

Overview | Page 19 - 24



Form A

Designation	LF	Diameter	LSCN	LSCX	BD	Max. rpm	Clamping Key
HSK63A-C20-85	85	2.0-20.0	-	60	52	8,000	9HC22
HSK63A-C20-□	95, 110, 135	2.0-20.0	58	68, 80, 80, 80	52	8,000	9HC22
HSK63A-C25-90	90	3.0-25.0	59	65	60	8,000	9HC25
HSK63A-C25-□	130, 150	3.0-25.0	61	75, 80, 80	60	8,000	9HC25
HSK63A-C32-110	110	3.0-32.0	66	83	69	6,000	9HC32
HSK63A-C32-130	130, 150	3.0-32.0	70	107	69	6,000	9HC32
HSK100A-C20-□	115, 135, 165	2.0-20.0	58	80	52	8,000	9HC22
HSK100A-C25-□	115, 135, 165	3.0-25.0	61	80	60	8,000	9HC25
HSK100A-C32-115	115	3.0-32.0	66	83	69	6,000	9HC32
HSK100A-C32-□	135, 165	3.0-32.0	70	107	69	6,000	9HC32

For models: HSK40A-C20-100, HSK50A-C20-95, HSK63A-C16-75, HSK63A-C20-85, HSK63A-C25-90 and HSK63A-C32-110, NK and CCNK clamping sleeves cannot be used.

# HSK DIN69893 Form A / E / F

HIGH SPEED MULTI-LOCK MILLING CHUCK – HSK FORM A / E / F

Overview | Page 19 - 24



Form A



Form E

Designation	LF	Diameter	LSCN	LSCX	BD	Max. rpm	Roller Key
HSK40A-C16-80G	80G	2.0-16.0	51	60	40	30,000	GH16
HSK40A-C20-100G	100G	2.0-20.0	-	57	48	30,000	GH20
HSK40E-C16-80G	80G	2.0-16.0	51	60	40	30,000	GH16
HSK40E-C20-100G	100G	2.0-20.0	-	57	48	30,000	GH20
HSK63A-C20-85G	85G	2.0-20.0	-	60	48	25,000	GH20
HSK63A-C20-□	95G, 110G	2.0-20.0	58	68, 80, 80, 80	48	25,000	GH20
HSK63A-C25-90G	90G	3.0-25.0	59	65	55	20,000	GH25
HSK63A-C25-130G	130G	3.0-25.0	61	75, 80	55	20,000	GH25
HSK63A-C32-□	110G, 130G	3.0-32.0	66	83, 103, 107	68	20,000	GH32
HSK100A-C20-□	115G, 135G, 165G	2.0-20.0	58	80	48	20,000	GH20
HSK100A-C25-□	115G, 135G, 165G	3.0-25.0	61	80	55	15,000	GH25

For models: HSK40A-C20-100G, HSK40E-C20-100G, HSK50A-C20-95G, HSK63A-C16-75G, HSK63A-C20-85G and HSK63A-C20-110G, NK and CCNK clamping sleeves cannot be used.



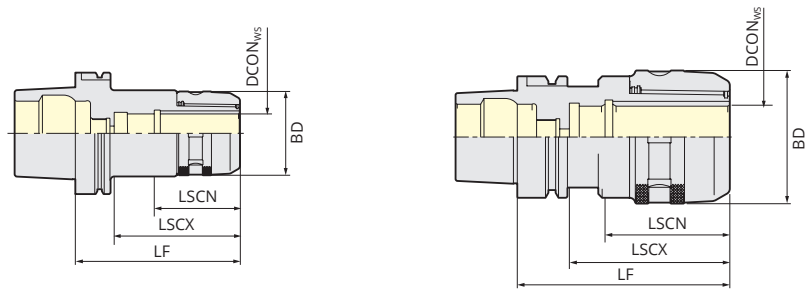

Collet	Jet Cover Cap	O-ring Cover Cap	Cover Cap Spanner
CCK20-□, KM20-□	CKFN20-□	CKFN20-□C	CCKLN20
CCK20-□, CCNK20-□, KM20-□, NK20-□	CKFN20-□	CKFN20-□C	CCKLN20
CCK25-□, KM25-□	CKFN25-□	CKFN25-□C	CCKLN25
CCK25-□, CCNK25-□, KM25-□, NK25-□	CKFN25-□	CKFN25-□C	CCKLN25
CCK32-□, KM32-□	CKFN32-□	CKFN32-□C	CCKLN32
CCK32-□, CCNK32-□, KM32-□, NK32-□	CKFN32-□	CKFN32-□C	CCKLN32
CCK20-□, CCNK20-□, KM20-□, NK20-□	CKFN20-□	CKFN20-□C	CCKLN20
CCK25-□, CCNK25-□, KM25-□, NK25-□	CKFN25-□	CKFN25-□C	CCKLN25
CCK32-□, CCNK32-□, KM32-□, NK32-□	CKFN32-□	CKFN32-□C	CCKLN32
CCK32-□, CCNK32-□, KM32-□, NK32-□	CKFN32-□	CKFN32-□C	CCKLN32

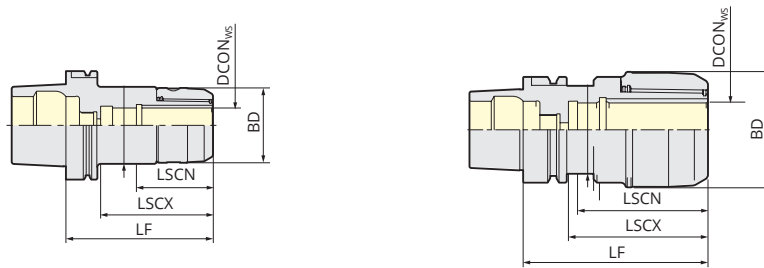

Collet	Jet Cover Cap	O-ring Cover Cap	Cover Cap Spanner
CCK16-□, KM16-□	CKFN16-□	CKFN16-□C	CCKLN16
CCK20-□, KM20-□	CKFN20-□	CKFN20-□C	CCKLN20
CCK16-□, KM16-□	CKFN16-□	CKFN16-□C	CCKLN16
CCK20-□, KM20-□	CKFN20-□	CKFN20-□C	CCKLN20
CCK20-□, KM20-□	CKFN20-□	CKFN20-□C	CCKLN20
CCK20-□, CCNK20-□, KM20-□, NK20-□	CKFN20-□	CKFN20-□C	CCKLN20
CCK25-□, KM25-□	CKFN25-□	CKFN25-□C	CCKLN25
CCK25-□, CCNK25-□, KM25-□, NK25-□	CKFN25-□	CKFN25-□C	CCKLN25
CCK32-□, KM32-□	CKFN32-□	CKFN32-□C	CCKLN32
CCK20-□, CCNK20-□, KM20-□, NK20-□	CKFN20-□	CKFN20-□C	CCKLN20
CCK25-□, CCNK25-□, KM25-□, NK25-□	CKFN25-□	CKFN25-□C	CCKLN25

# HSK DIN69893 Form A / E / F

## ZERO FIT SLIM CHUCK – HSK FORM A

Overview | Page 25 - 27



Form A

Designation	LF	Diameter	LSCN	LB	LB1	BD	BD1	Max. rpm
HSK40A-SZF6C-105	105	0.7-6.0	26-31	32	70	19.5	40.5	15,000
HSK40A-SZF10C-105	105	1.75-10.0	35-41	32	70	27.5	48.5	15,000
HSK40A-SZF16C-120	120	2.75-16.0	45-57	48	85	40	59.5	12,000
HSK63A-SZF6C-120	120	0.7-6.0	26-31	68	-	19.5	40.5	15,000
HSK63A-SZF10C-□	105, 150	1.75-10.0	35-41	53, 98	-	27.5	48.35	15,000
HSK63A-SZF16C-150	150	2.75-16.0	45-57	76	93	40	59.5	12,000
HSK63A-SZF25C-135	135	7.5-25.4	60-65	57	-	55	66.5	10,000
HSK100A-SZF6C-120	120	0.7-6.0	26-31	54	-	19.5	40.5	15,000
HSK100A-SZF10C-150	150	1.75-10.0	35-41	85	-	27.5	48.5	15,000
HSK100A-SZF16C-150	150	2.75-16.0	45-57	85	-	40	59.5	12,000
HSK100A-SZF25C-150	150	7.5-25.4	60-65	95	-	55	66.5	10,000

## ZERO FIT MULTI-LOCK – HSK FORM A

Overview | Page 25 - 27

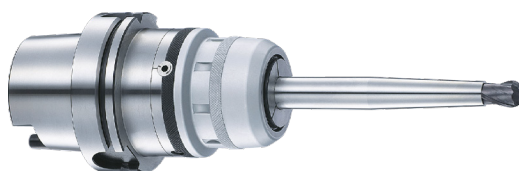

Form A

Designation	LF	Diameter	LSCN	LSCX	LB	LB1	BD	BD1	Max. rpm
HSK63A-CZF20-110	110	2.0-20.0	58	80	35	68	51.5	66.5	8,000
HSK63A-CZF25-110	110	3.0-25.0	59	80	35	68	59.5	74.5	8,000
HSK63A-CZF32-130	130	3.0-32.0	66	105	42	88	69	80.5	6,000
HSK100A-CZF20-115	115	2.0-20.0	58	80	35	-	51.5	66.5	8,000
HSK100A-CZF25-115	115	3.0-25.0	61	80	35	-	59.5	74.5	8,000
HSK100A-CZF32-115	115	3.0-32.0	66	83	42	-	69	80.5	6,000

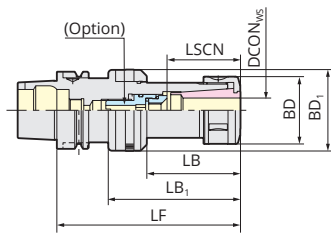

Fig. 1

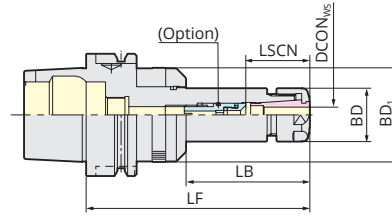

Fig. 2

Clamping Key	Collet	Stop Screw	TiN Clamping Nut (Standard)	Jet Type Clamping Nut	Jet Cover Cap	O-ring Cover Cap	Cover Cap Spanner	Fig.
SKL-6W	SK6-□	SKG6-6HG	SKN-6WK	SKN-6WKJ	SKJ6-□	SKJ6-□C	SKJL-6	1
SKL-10	SK10-□	SKG10-10HG	SKN-10K	SKN-10KJ	SKJ10-□	SKJ10-□C	SKJL-10	1
9HC16	SK16-□	SKG16-10HG	SKN-16B	SKN-16BJ	SKJ16-□	SKJ16-□C	SKJL-16	1
SKL-6W	SK6-□	SKG6-6HG	SKN-6WK	SKN-6WKJ	SKJ6-□	SKJ6-□C	SKJL-6	2
SKL-10	SK10-□	SKG10-10HG	SKN-10K	SKN-10KJ	SKJ10-□	SKJ10-□C	SKJL-10	2
9HC16	SK16-□	SKG16-10HG	SKN-16B	SKN-16BJ	SKJ16-□	SKJ16-□C	SKJL-16	2
9HC25	SK25-□	SKG25-18HGE	SKN-25B	SKN-25BJ	SKJ25-□	SKJ25-□C	SKJL-25	1
SKL-6W	SK6-□	SKG6-6HG	SKN-6WK	SKN-6WKJ	SKJ6-□	SKJ6-□C	SKJL-6	2
SKL-10	SK10-□	SKG10-10HG	SKN-10K	SKN-10KJ	SKJ10-□	SKJ10-□C	SKJL-10	2
9HC16	SK16-□	SKG16-12HG	SKN-16B	SKN-16BJ	SKJ16-□	SKJ16-□C	SKJL-16	2
9HC25	SK25-□	SKG25-18HGE	SKN-25B	SKN-25BJ	SKJ25-□	SKJ25-□C	SKJL-25	2

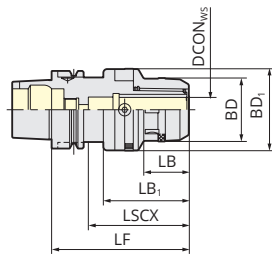

Fig. 1

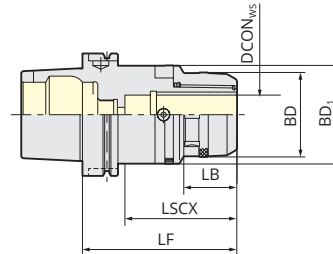

Fig. 2

Clamping Key	Collet	Jet Cover Cap	O-ring Cover Cap	Cover Cap Spanner	Fig.
9HC22	CCK20-□, KM20-□	CKFN20-□	CKFN20-□C	CCKLN20	1
9HC25	CCK25-□, KM25-□	CKFN25-□	CKFN25-□C	CCKLN25	1
9HC32	CCK32-□, KM32-□	CKFN32-□	CKFN32-□C	CCKLN32	1
9HC22	CCK20-□, CCNK20-□, KM20-□, NK20-□	CKFN20-□	CKFN20-□C	CCKLN20	2
9HC25	CCK25-□, CCNK25-□, KM25-□, NK25-□	CKFN25-□	CKFN25-□C	CCKLN25	2
9HC32	CCK32-□, CCNK32-□, KM32-□, NK32-□	CKFN32-□	CKFN32-□C	CCKLN32	2

# HSK FMH Face Mill Arbor



■ For Oil Hole Cutter  
For High Speed Cutter

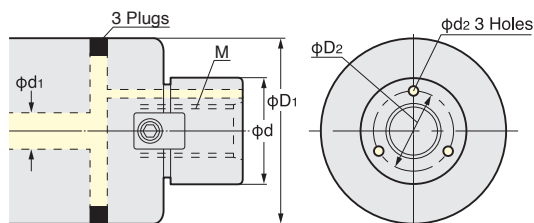
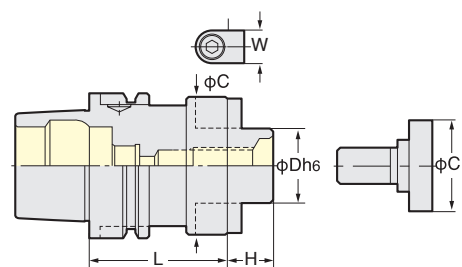

Code No.	Cutter Dia.	φd	φD1	M	Coolant Hole		
					φD2	φd1	φd2
FMH22	φ50, φ52	22	47	M10 P1.5	16	6 ~ 8	3
	φ63, φ66		60				
FMH27	φ80	27	76	M12 P1.75	19.5	8 ~ 10	3.5

## FMH Metric Series

Code No.	Arbor								Drive Key	Lock Bolt	G Cap Bolt	Weight (kg)
	D	L	H	C	C1	W						
HSK 63A-FMH16	- 37	- 45	16	45	17	37	20	8	FW 3	FM 8	-	1.0
-FMH22	- 47	- 45	22	45	18	47	16	10	FW 8	-	9GM10-30	1.1
			22	60	18	60	16	10				
-FMH27	- 60	- 60	27	60	20	60	18	12	FW11	-	9GM12-35	1.6
			27	90	20	90	18	12				
HSK100A-FMH22	- 47	- 105	22	105	18	47	16	10	FW 8	-	9GM10-30	3.4
			22	60	18	60	16	10				
-FMH22	- 60	- 60	22	60	18	60	16	10	FW 8	-	9GM10-30	2.9
			22	105	18	105	16	10				
-FMH27	- 60	- 60	27	60	20	60	18	12	FW 11	-	9GM12-35	2.9
			27	90	20	90	18	12				
-FMH27	- 76	- 60	27	60	20	76	18	12	FW 11	-	9GM12-35	3.2
			27	90	20	90	18	12				





# IT-SK Shank DIN 69871

SLIM CHUCK STANDARD - IT / NIT / MIT

Overview | Page 8 - 15

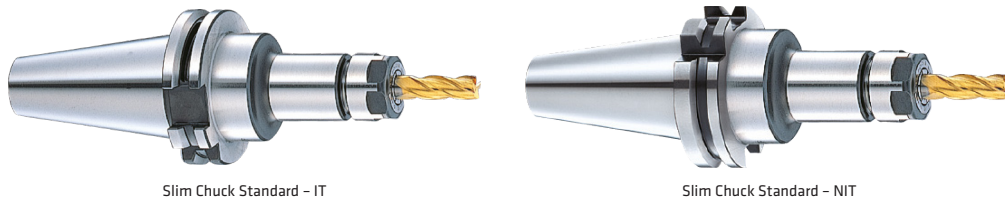

Designation	LF	Diameter	LSCN	LB	LB1	BD	BD1	Max. rpm
IT40-SK6-□	60, 90, 120, 150	0.7-6.0	21-35	38, 48, 62, 60	38, 48, 62, 82	19.5	19.5, 19.5, 32, 25	12,000
IT40-SK10-□	60, 90, 120, 150	1.75-10.0	30-50	40, 50, 60, 73	40, 50, 82, 114	27.5	27.5, 27.5, 32, 33.5	12,000
IT40-SK16-60	60	2.75-16.0	50-65	40	-	40	-	12,000
IT40-SK16-□	90, 120, 150	2.75-16.0	45-70	54, 84, 114	-	40	-	12,000
IT40-SK20-□	90, 120	3.5-20.0	47-80	70, 100	-	48.5	-	10,000
IT50-SK10-□	105, 135, 165	1.75-10.0	30-50	65, 70, 75	65, 95, 125	27.5	27.5, 32, 32	12,000
IT50-SK20-□	105, 135, 165	3.5-20.0	47-80	65, 95, 125	-	48.5	-	10,000
NIT40-SK6C-□	60, 90, 120	0.7-6.0	21-35	38, 48, 62, 60	38, 48, 62, 82	19.5	19.5, 19.5, 32, 25	12,000
NIT40-SK10C-□	60, 90, 120, 150	1.75-10.0	30-50	40, 50, 60, 73	40, 50, 82, 114	27.5	27.5, 27.5, 32, 33.5	12,000
NIT40-SK16C-□	90, 120, 150	2.75-16.0	45-70	54, 84, 114	-	40	-	12,000
NIT40-SK20C-□	90, 120	3.5-20.0	47-80	70, 100	-	48.5	-	10,000
NIT50-SK6C-□	135, 165	0.7-6.0	21-35	60, 62, 62	60, 93, 117	19.5	19.5, 32, 32	12,000
NIT50-SK10C-□	105, 135, 165	1.75-10.0	30-50	65, 70, 75	65, 95, 125	27.5	27.5, 32, 32	12,000
NIT50-SK16C-□	105, 135, 165	2.75-16.0	40-70	65, 95, 92	65, 95, 125	40	40, 40, 50	12,000
NIT50-SK20C-□	105, 135, 165	3.5-20.0	47-80	65, 95, 125	-	48.5	-	10,000

MINI MINI CHUCK - IT / NIT / MIT

Overview | Page 16 - 17

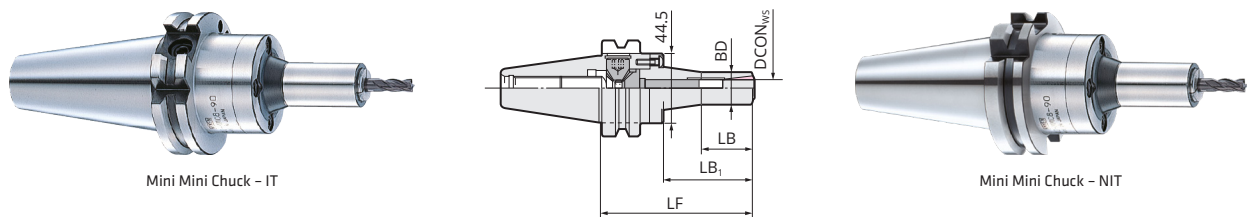

Designation	LF	Diameter	LSCN	LB	BD	Max. rpm	Collet Standard	Collet Metallic Sealing	Jet Collet
IT40X-MMC8C-□-AA	90, 120	2.0-8.0	9.4-15.0	33, 40	20	30,000	PMK8-□	VMK8-□	VMK8-□J
IT40X-MMC12C-□-AA	90, 120	4.0-12.0	20.0-31.0	35, 60	30	30,000	PMK12-□	VMK12-□	VMK12-□J
IT50X-MMC8C-□-AA	105, 135, 165	2.0-8.0	9.4-15.0	33, 40, 40	20	20,000	PMK8-□	VMK8-□	VMK8-□J
IT50X-MMC12C-□-AA	105, 135, 165	4.0-12.0	20.0-31.0	35, 60, 70	30	20,000	PMK12-□	VMK12-□	VMK12-□J
NIT40-MMC8C-□-AA	90, 120	2.0-8.0	9.4-15.0	33, 40	20	30,000	PMK8-□	VMK8-□	VMK8-□J
NIT40-MMC12C-□-AA	90, 120	4.0-12.0	20.0-31.0	35, 60	30	30,000	PMK12-□	VMK12-□	VMK12-□J
NIT50-MMC8C-□-AA	105, 135, 165	2.0-8.0	9.4-15.0	33, 40, 40	20	20,000	PMK8-□	VMK8-□	VMK8-□J
NIT50-MMC12C-□-AA	105, 135, 165	4.0-12.0	20.0-31.0	35, 60, 70	30	20,000	PMK12-□	VMK12-□	VMK12-□J

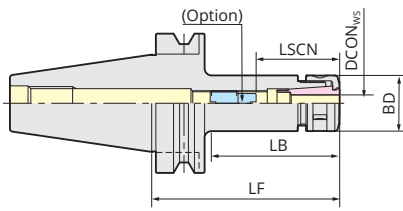

Fig. 1

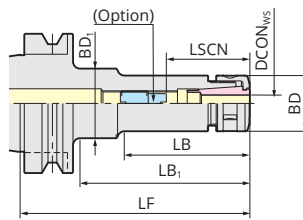

Fig. 2

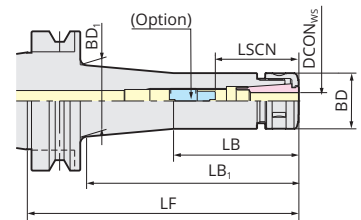

Fig. 3

Clamping Key	Collet	Stop Screw	TiN Clamping Nut (Standard)	Jet Type Clamping Nut	Jet Cover Cap	O-ring Cover Cap	Cover Cap Spanner	Fig.
SKL-6W	SK6-□	SKG-8	SKN-6WK	SKN-6WKJ	SKJ6-□	SKJ6-□C	SKJL-6	1, 1, 2, 3
SKL-10	SK10-□	SKG-12L	SKN-10K	SKN-10KJ	SKJ10-□	SKJ10-□C	SKJL-10	1, 1, 2, 3
9HC16	SK16-□	SKG-18S	SKN-16B	SKN-16BJ	SKJ16-□	SKJ16-□C	SKJL-16	1
9HC16	SK16-□	SKG-18L	SKN-16B	SKN-16BJ	SKJ16-□	SKJ16-□C	SKJL-16	1
9HC22	SK20-□	SKG-22	SKN-20B	SKN-20BJ	SKJ25-□	SKJ25-□C	SKJL-25	1
SKL-10	SK10-□	SKG-12L	SKN-10K	SKN-10KJ	SKJ10-□	SKJ10-□C	SKJL-10	1, 2, 2
9HC22	SK20-□	SKG-22	SKN-20B	SKN-20BJ	SKJ25-□	SKJ25-□C	SKJL-25	1
SKL-6W	SK6-□	SKG-8	SKN-6WK	SKN-6WKJ	SKJ6-□	SKJ6-□C	SKJL-6	1, 1, 2, 3
SKL-10	SK10-□	SKG-12L	SKN-10K	SKN-10KJ	SKJ10-□	SKJ10-□C	SKJL-10	1, 1, 2, 3
9HC16	SK16-□	SKG-18L	SKN-16B	SKN-16BJ	SKJ16-□	SKJ16-□C	SKJL-16	1
9HC22	SK20-□	SKG-22	SKN-20B	SKN-20BJ	SKJ25-□	SKJ25-□C	SKJL-25	1
SKL-6W	SK6-□	SKG-8	SKN-6WK	SKN-6WKJ	SKJ6-□	SKJ6-□C	SKJL-6	1, 2, 2
SKL-10	SK10-□	SKG-12L	SKN-10K	SKN-10KJ	SKJ10-□	SKJ10-□C	SKJL-10	1, 2, 2
9HC16	SK16-□	SKG-18L	SKN-16B	SKN-16BJ	SKJ16-□	SKJ16-□C	SKJL-16	1, 1, 2
9HC22	SK20-□	SKG-22	SKN-20B	SKN-20BJ	SKJ25-□	SKJ25-□C	SKJL-25	1

# IT-SK Shank DIN 69871

STANDARD MULTI-LOCK MILLING CHUCK - IT / NIT / MIT

Overview | Page 19 - 24



Standard Multi-Lock Milling Chuck - IT



Standard Multi-Lock Milling Chuck - NIT

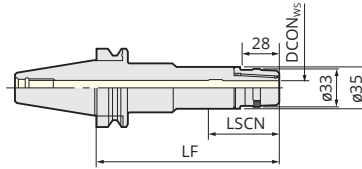

Multi-Lock Milling Chuck C12

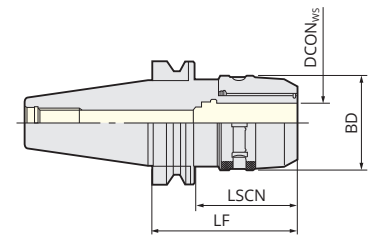

Designation	LF	Diameter	LSCN	LSCX	BD	Max. rpm	Clamping Key
IT40-C20-□	80, 90	2.0-20.0	53	80	52	7,000	9HC22
IT40-C20-120	120	2.0-20.0	53	80	52	7,000	9HC22
IT40-C25-□	85, 105, 120	3.0-25.0	59	80	60	6,000	9HC25
IT40-C32-□	95, 105, 120	3.0-32.0	64.5	82, 95, 105	64	6,000	9HC25
IT50-C20-□	105, 135, 165	2.0-20.0	53	80	52	8,000	9HC22
IT50-C25-□	105, 135	3.0-25.0	59	80	60	8,000	9HC25
IT50-C32-□	105, 120, 135	3.0-32.0	64.5	105	69	6,000	9HC32



Multi-Lock Standard - MIT

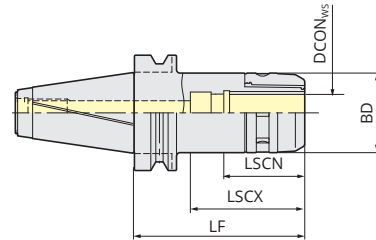

Collet	Jet Cover Cap	O-ring Cover Cap	Cover Cap Spanner
CCK20-□, CCNK20-□, KM20-□, NK20-□ CCK20-□, KM20-□	CKFN20-□	CKFN20-□C	CCKLN20
CCK25-□, CCNK25-□, KM25-□, NK25-□	CKFN25-□	CKFN25-□C	CCKLN25
CCK32-□, CCNK32-□, KM32-□, NK32-□	CKFN32T-□	CKFN32-□C	CCKLN32
CCK20-□, CCNK20-□, KM20-□, NK20-□	CKFN20-□	CKFN20-□C	CCKLN20
CCK25-□, CCNK25-□, KM25-□, NK25-□	CKFN25-□	CKFN25-□C	CCKLN25
CCK32-□, CCNK32-□, KM32-□, NK32-□	CKFN32-□	CKFN32-□C	CCKLN32

For the models C20-120, C42-95 and C42-95P the clamping sleeves NK and CCNK cannot be used.

# IT-SK Shank DIN 69871

ZERO FIT SLIM CHUCK - IT / NIT

Overview | Page 25 - 27

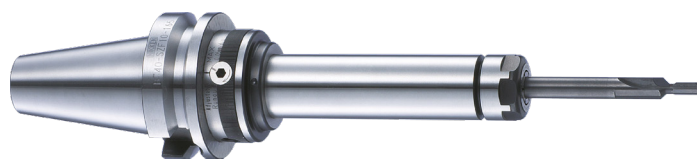

Zero Fit Slim Chuck - IT

Designation	LF	Diameter	LSCN	LB	LB1	BD	BD1	Max. rpm
IT40-SZF6-□	90, 150	0.7-6.0	21-35	45, 89	-	19.5	40.5	15,000
IT40-SZF10-□	120, 150	1.75-10.0	30-50	57, 87	-	27.5	48.5	15,000
IT40-SZF16-□	120, 150	2.75-16.0	45-65	51, 81	-	40	59.5	12,000
IT40-SZF25-□	120, 150	7.5-25.4	55-85	49, 79	85, 115	55	66.5	10,000
IT50-SZF6-□	105, 165	0.7-6.0	21-35	60, 67	-	19.5	40.5, 59.5	15,000
IT50-SZF10-□	105, 165	1.75-10.0	30-50	60, 65	-	27.5	48.5, 59.5	15,000
IT50-SZF16-□	105, 165	2.75-16.0	45-65	60, 120	-	40	59.5	12,000
IT50-SZF25-□	120, 165	7.5-25.4	55-85	75, 120	-	55	66.5	10,000

ZERO FIT MULTI-LOCK - IT / NIT

Overview | Page 25 - 27

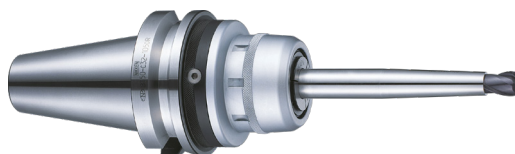

Zero Fit Multi-Lock - IT

Designation	LF	Diameter	LSCN	LSCX	LB	LB1	BD	BD1	Max. rpm
IT40-CZF20-105	105	2.0-20.0	53	80	35	70	51.5	66.5	7,000
IT40-CZF25-105	105	3.0-25.0	59	80	35	70	59.5	47.5	8,000
IT40-CZF32-120	120	3.0-32.0	64.5	105	42	85	69	80.5	6,000
IT50-CZF20-105	105	2.0-20.0	53	80	35	-	51.5	66.5	8,000
IT50-CZF25-105	105	3.0-25.0	59	80	35	-	59.5	74.5	8,000
IT50-CZF32-120	120	3.0-32.0	64.5	105	42	-	69	80.5	6,000



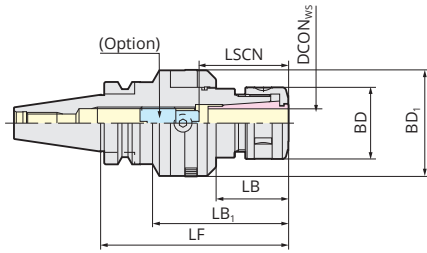

Fig. 1

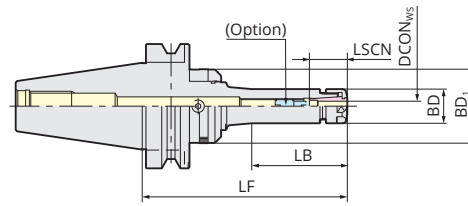

Fig. 2

Clamping Key	Collet	Stop Screw	TiN Clamping Nut (Standard)	Jet Type Clamping Nut	Jet Cover Cap	O-ring Cover Cap	Cover Cap Spanner	Fig.
SKL-6W	SK6-□	SKG-8	SKN-6WK	SKN-6WKJ	SKJ6-□	SKJ6-□C	SKJL-6	2
SKL-10	SK10-□	SKG-12L	SKN-10K	SKN-10KJ	SKJ10-□	SKJ10-□C	SKJL-10	2
9HC16	SK16-□	SKG-18L	SKN-16B	SKN-16BJ	SKJ16-□	SKJ16-□C	SKJL-16	2
9HC25	SK25-□	SKG-28	SKN-25B	SKN-25BJ	SKJ25-□	SKJ25-□C	SKJL-25	1
SKL-6W	SK6-□	SKG-8	SKN-6WK	SKN-6WKJ	SKJ6-□	SKJ6-□C	SKJL-6	2
SKL-10	SK10-□	SKG-12L	SKN-10K	SKN-10KJ	SKJ10-□	SKJ10-□C	SKJL-10	2
9HC16	SK16-□	SKG-18L	SKN-16B	SKN-16BJ	SKJ16-□	SKJ16-□C	SKJL-16	2
9HC25	SK25-□	SKG-28	SKN-25B	SKN-25BJ	SKJ25-□	SKJ25-□C	SKJL-25	2

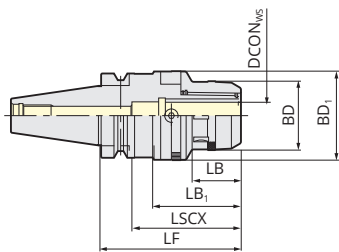

Fig. 1

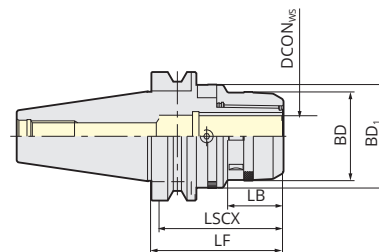

Fig. 2

Clamping Key	Collet	Jet Cover Cap	O-ring Cover Cap	Cover Cap Spanner	Fig.
9HC22	CCK20-□, KM20-□	CKFN20-□	CKFN20-□C	CCKLN20	1
9HC25	CCK25-□, KM25-□	CKFN25-□	CKFN25-□C	CCKLN25	1
9HC32	CCK32-□, KM32-□	CKFN32-□	CKFN32-□C	CCKLN32	1
9HC22	CCK20-□, KM20-□	CKFN20-□	CKFN20-□C	CCKLN20	2
9HC25	CCK25-□, KM25-□	CKFN25-□	CKFN25-□C	CCKLN25	2
9HC32	CCK32-□, KM32-□	CKFN32-□	CKFN32-□C	CCKLN32	2

# NBT FMH Face Mill Arbor



FMH

■ For Oil Hole Cutter  
For High Speed Cutter

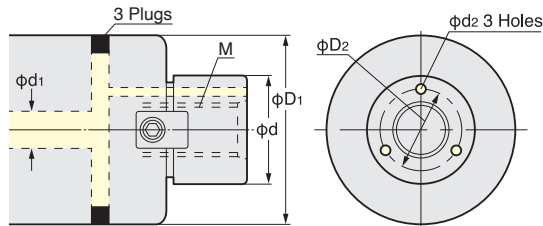
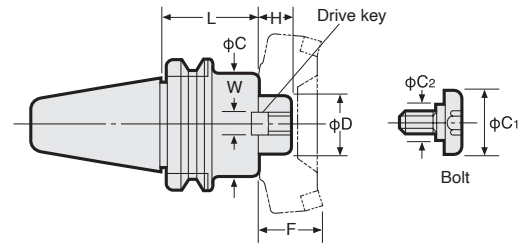

Code No.	Cutter Dia.	φd	φD1	M	Coolant Hole		
					φD2	φd1	φd2
FMH16	φ40	16	37	M8 P1.25	12	6	2
FMH22	φ50, φ52 φ63, φ66	22	47 60	M10 P1.5	16	6 ~ 8	3
FMH27	φ80	27	60, 76	M12 P1.75	18.5	8 ~ 10	3.5

## FMH Metric Series

Code No.	Arbor							Drive Key	Lock Bolt	G Cap Bolt	Weight (kg)
	D	L	H	C	C1	W					
NBT30-FMH16- 37 - 35	16	35	17	37	20	8	FW 3	FM 8	-	0.6	
-FMH22- 47 - 45	22	45	18	47	16	10	FW 8	-	9GM10-30	0.8	
-FMH27- 60 - 45	27	45	20	60	18	12	FW 11	-	9M12-35	1.0	
NBT40-FMH16- 37 - 40	16	40	17	37	20	8	FW 3	FM 8	-	1.1	
(NIT40)-FMH22- 47 - 45	22	45	18	47	16	10	FW 8	-	9M10-30	1.3	
- 60	22	60								1.5	
-FMH22- 60 - 45	22	45	18	60	16	10	FW 8	-	9M10-30	1.5	
- 60	22	60								1.8	
-FMH27- 60 - 45	27	45	20	60	18	12	FW 11	-	9M12-35	1.5	
- 60	27	60								1.8	
-FMH27- 76 - 60	27	60	20	76	18	12	FW 11	-	9M12-35	2.1	
- 90	27	90								2.8	
NBT50-FMH16- 37 - 60	16	60	17	37	20	8	FW 3	FM 8	-	3.8	
(NIT50) -105	16	105								4.1	
-FMH22- 47 - 60	22	60	18	47	16	10	FW 8	-	9GM10-30	4.1	
- 105	22	105								4.7	
-FMH22- 60 - 60	22	60	18	60	16	10	FW 8	-	9GM10-30	4.2	
- 105	22	105								5.2	
-FMH27- 60 - 45	27	45	20	60	18	12	9FWE27	-	9GM12-35	3.9	
- 90	27	90					FW 8	-		5.0	
-FMH27- 76 - 45	27	45	20	76	18	12	FW 10	-	9GM12-35	4.0	
- 90	27	90					FW 11	-		5.6	



# BT JIS B6339 / MAS 403

SLIM CHUCK STANDARD - BT / NBT / MBT

Overview | Page 8 - 15

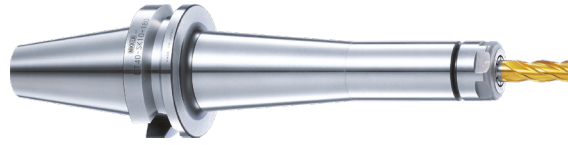

Slim Chuck Standard - BT

Designation	LF	Diameter	LSCN	LB	LB1	BD	BD1
BT30-SK6-□	60, 90, 120	0.7-6.0	21-35	33, 56, 62	33, 65, 95	19.5	19.5, 32, 32
BT30-SK10-□	60, 90, 120	1.75-10.0	30-50	35, 50, 65, 95	-	27.5	-
BT30-SK16-60	60	2.75-16.0	45-60	37	-	40	-
BT30-SK16-90	90	2.75-16.0	45-65	67	-	40	-
BT30-SK16-120	120	2.75-16.0	40-70	97	-	40	-
BT40-SK6-□	60, 90, 120	0.7-6.0	21-35	30, 51, 60, 60	30, 60, 90, 120	19.5	19.5, 32, 32, 25
BT40-SK10-□	60, 90, 120	1.75-10.0	30-50	32, 45, 48, 73	32, 45, 60, 90	27.5	27.5, 27.5, 40, 40
BT40-SK10-150	150	1.75-10.0	30-50	73, 73	118, 148	27.5	34.5, 39
BT40-SK16-60	60	2.75-16.0	50-65	32	-	40	-
BT40-SK16-□	90, 120, 150	2.75-16.0	45-60	58, 88, 118	-	40	-
BT40-SK20-60	60	3.5-20.0	47-60	32	-	48.5	-
BT40-SK20-□	90, 120	3.5-20.0	47-80	60, 90	-	48.5	-
BT50-SK10-□	105, 135	1.75-10.0	30-50	57, 70	57, 92	27.5	27.5, 32
BT50-SK10-165	165	1.75-10.0	30-50	75, 75	114, 151	27.5	32, 36
BT50-SK16-□	105, 135	2.75-16.0	45-70	62, 92	-	40	-
BT50-SK16-165	165	2.75-16.0	45-70	90, 90	122, 157	40	50, 52



Slim Chuck Standard - BT, NBT

NBT30-SK6C-□	60, 90, 120	0.7-6.0	26-31	33, 56, 62	33, 65, 95	19.5	19.5, 32, 32
NBT30-SK10C-□	60, 90, 120	1.75-10.0	33-41	22, 35, 50, 65, 95	-	27.5	-
NBT30-SK16C-60	60	2.75-16.0	47-52	37	-	40	-
NBT30-SK16C-75	75	2.75-16.0	45-52	52	-	40	-
NBT30-SK16C-□	90, 120	2.75-16.0	45-57	67, 97	-	40	-
NBT30-SK20-60	60	3.5-20.0	65-70	37	-	48.5	-
NBT30-SK20C-75	75	3.5-20.0	55-55	52	-	48.5	-
NBT40-SK6C-□	60, 90, 120	0.7-6.0	26-31	30, 51, 60, 60	30, 60, 90, 120	19.5	19.5, 32, 32, 25
NBT40-SK10C-□	60, 90, 120	1.75-10.0	33-41	32, 45, 48, 75	32, 45, 60, 90	27.5	27.5, 27.5, 40, 40
NBT40-SK10C-150	150	1.75-10.0	33-41	75	118, 148	27.5	34.5, 39
NBT40-SK16C-60	60	2.75-16.0	45-52	32	-	40	-
NBT40-SK16C-□	90, 120, 150	2.75-16.0	45-57	43, 58, 88, 118	-	40	-
NBT40-SK20C-60	60	3.5-20.0	57-63	32	-	48.5	-
NBT50-SK10C-□	105, 135	1.75-10.0	33-41	57, 70	57, 92	27.5	27.5, 32
NBT50-SK16C-□	105, 135	2.75-16.0	45-57	62, 92	-	40	-
NBT50-SK16C-165	165	2.75-16.0	45-57	90	122, 157	40	50, 52

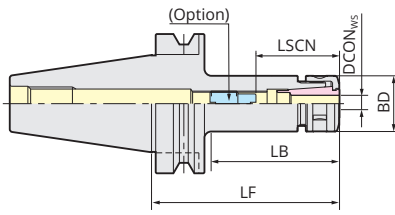

Fig. 1

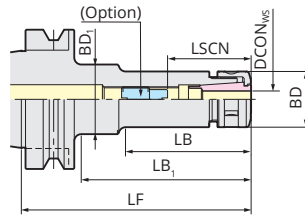

Fig. 2

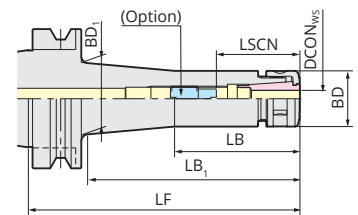

Fig. 3

Max. rpm	Roller Key	Collet	Stop Screw	TiN Clamping Nut (Standard)	Jet Type Clamping Nut	Jet Cover Cap	O-ring Cover Cap	Cover Cap Spanner	Fig.
15,000	SKL-6W	SK6-□	SKG-8	SKN-6WK	SKN-6WKJ	SKJ6-□	SKJ6-□C	SKJL-6	1, 2, 2
15,000	SKL-10	SK10-□	SKG-12L	SKN-10K	SKN-10KJ	SKJ10-□	SKJ10-□C	SKJL-10	1
10,000	9HC16	SK16-□	SKG-12L	SKN-16B	SKN-16BJ	SKJ16-□	SKJ16-□C	SKJL-16	1
10,000	9HC16	SK16-□	SKG-12	SKN-16B	SKN-16BJ	SKJ16-□	SKJ16-□C	SKJL-16	1
10,000	9HC16	SK16-□	SKG-18L	SKN-16B	SKN-16BJ	SKJ16-□	SKJ16-□C	SKJL-16	1
15,000	SKL-6W	SK6-□	SKG-8	SKN-6WK	SKN-6WKJ	SKJ6-□	SKJ6-□C	SKJL-6	1, 2, 2, 3
15,000	SKL-10	SK10-□	SKG-12L	SKN-10K	SKN-10KJ	SKJ10-□	SKJ10-□C	SKJL-10	1, 1, 2, 2
12,000	SKL-10	SK10-□	SKG-12L	SKN-10K	SKN-10KJ	SKJ10-□	SKJ10-□C	SKJL-10	3
12,000	9HC16	SK16-□	SKG-18S	SKN-16B	SKN-16BJ	SKJ16-□	SKJ16-□C	SKJL-16	1
12,000	9HC16	SK16-□	SKG-18L	SKN-16B	SKN-16BJ	SKJ16-□	SKJ16-□C	SKJL-16	1
12,000	9HC22	SK20-□	SKG-22	SKN-20B	SKN-20BJ	SKJ25-□	SKJ25-□C	SKJL-25	1
12,000	9HC22	SK20-□	SKG-22	SKN-20B	SKN-20BJ	SKJ25-□	SKJ25-□C	SKJL-25	1
15,000	SKL-10	SK10-□	SKG-12L	SKN-10K	SKN-10KJ	SKJ10-□	SKJ10-□C	SKJL-10	1, 2
12,000	SKL-10	SK10-□	SKG-12L	SKN-10K	SKN-10KJ	SKJ10-□	SKJ10-□C	SKJL-10	2, 3
12,000	9HC16	SK16-□	SKG-18L	SKN-16B	SKN-16BJ	SKJ16-□	SKJ16-□C	SKJL-16	1
10,000	9HC16	SK16-□	SKG-18L	SKN-16B	SKN-16BJ	SKJ16-□	SKJ16-□C	SKJL-16	2, 3

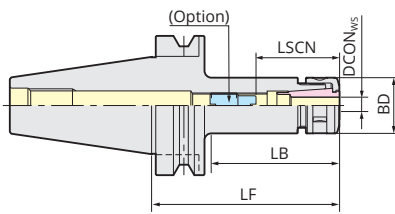

Fig. 1

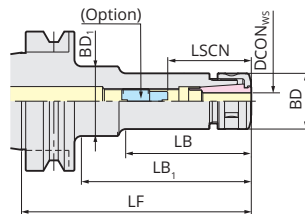

Fig. 2

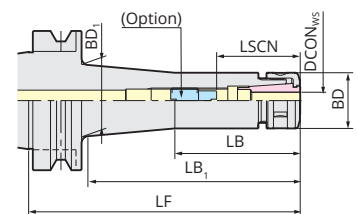

Fig. 3

15,000	SKL-6W	SK6-□	SKG6-6HG	SKN-6WK	SKN-6WKJ	SKJ6-□	SKJ6-□C	SKJL-6	1, 2, 2
15,000	SKL-10	SK10-□	SKG10-10HG	SKN-10K	SKN-10KJ	SKJ10-□	SKJ10-□C	SKJL-10	1
10,000	9HC16	SK16-□	SKG16-12HGE	SKN-16B	SKN-16BJ	SKJ16-□	SKJ16-□C	SKJL-16	1
10,000	9HC16	SK16-□	SKG16-10HG	SKN-16B	SKN-16BJ	SKJ16-□	SKJ16-□C	SKJL-16	1
10,000	9HC16	SK16-□	SKG16-12HG	SKN-16B	SKN-16BJ	SKJ16-□	SKJ16-□C	SKJL-16	1
10,000	9HC22	SK20-□	SKG-12S	SKN-20B	SKN-20BJ	SKJ25-□	SKJ25-□C	SKJL-25	1
10,000	9HC22	SK20-□	SKG20-12HGE	SKN-20B	SKN-20BJ	SKJ25-□	SKJ25-□C	SKJL-25	1
15,000	SKL-6W	SK6-□	SKG6-6HG	SKN-6WK	SKN-6WKJ	SKJ6-□	SKJ6-□C	SKJL-6	1, 2, 2, 3
15,000	SKL-10	SK10-□	SKG10-10HG	SKN-10K	SKN-10KJ	SKJ10-□	SKJ10-□C	SKJL-10	1, 1, 2, 2
12,000	SKL-10	SK10-□	SKG10-10HG	SKN-10K	SKN-10KJ	SKJ10-□	SKJ10-□C	SKJL-10	3
12,000	9HC16	SK16-□	SKG16-10HG	SKN-16B	SKN-16BJ	SKJ16-□	SKJ16-□C	SKJL-16	1
12,000	9HC16	SK16-□	SKG16-12HG	SKN-16B	SKN-16BJ	SKJ16-□	SKJ16-□C	SKJL-16	1
12,000	9HC22	SK20-□	SKG20-16HG	SKN-20B	SKN-20BJ	SKJ25-□	SKJ25-□C	SKJL-25	1
15,000	SKL-10	SK10-□	SKG10-10HG	SKN-10K	SKN-10KJ	SKJ10-□	SKJ10-□C	SKJL-10	1, 2
12,000	9HC16	SK16-□	SKG16-12HG	SKN-16B	SKN-16BJ	SKJ16-□	SKJ16-□C	SKJL-16	1
10,000	9HC16	SK16-□	SKG16-12HG	SKN-16B	SKN-16BJ	SKJ16-□	SKJ16-□C	SKJL-16	2, 3





Slim Chuck High Speed – BT

Designation	LF	Diameter	LSCN	LB	LB1	BD	BD1
BT30-SK6-□	60P, 90P, 120P	0.7-6.0	21-35	33, 56, 62	33, 65, 95	19.5	19.5, 32, 32
BT30-SK10-□	60P, 90P, 120P	1.75-10.0	30-50	35, 50, 65, 95	-	27.5	-
BT30-SK16-60P	60P	2.75-16.0	45-60	37	-	40	-
BT30-SK16-90P	90P	2.75-16.0	45-65	67	-	40	-
BT30-SK16-120P	120P	2.75-16.0	40-70	97	-	40	-
BT30-SK20-60P	60P	3.5-20.0	65-70	37	-	48.5	-
BT30-SK20-75P	75P	3.5-20.0	70-75	52	-	48.5	-
BT30-SK20-90P	90P	3.5-20.0	65-75	67	-	48.5	-
BT30-SK25-90P	90P	7.5-25.4	55-75	67	-	55	-
BT40-SK6-□	60P, 90P, 120P	0.7-6.0	21-35	30, 51, 60, 60	30, 60, 90, 120	19.5	19.5, 32, 32, 25
BT40-SK10-□	60P, 90P, 120P	1.75-10.0	30-50	32, 45, 48, 73	32, 45, 60, 90	27,5	27.5, 2735, 40, 40
BT40-SK10-150P	150P	1.75-10.0	30-50	73	118, 148	27.5	34.5, 39
BT40-SK16-60P	60P	2.75-16.0	50-65	32	-	40	-
BT40-SK16-75P	75P	2.75-16.0	40-67	43	-	40	-
BT40-SK16-□	90P, 120P, 150P	2.75-16.0	45-60	58, 88, 118	-	40	-
BT40-SK20-60P	60P	3.5-20.0	47-60	32	-	48.5	-
BT40-SK20-□	90P, 120P	3.5-20.0	47-80	60, 90	-	48.5	-
BT50-SK10-□	105P, 135P	1.75-10.0	30-50	57, 70	57, 92	27.5	27.5, 32
BT50-SK10-165P	165P	1.75-10.0	30-50	75	114, 151	27.5	32, 36
BT50-SK16-□	105P, 135P	2.75-16.0	45-70	62, 92	-	40	-
BT50-SK16-165P	165P	2.75-16.0	45-70	90	122, 157	40	50, 52
NBT30-SK6C-□	60P, 90P	0.7-6.0	26-31	33, 56	-	19.5	19.5, 32
NBT30-SK10C-□	60P, 90P	1.75-10.0	33-41	22, 35, 50, 65	-	27.5	-
NBT30-SK16C-60P	60P	2.75-16.0	47-52	37	-	40	-
NBT30-SK16C-75P	75P	2.75-16.0	45-52	52	-	40	-
NBT30-SK16C-90P	90P	2.75-16.0	45-57	67	-	40	-
NBT40-SK6C-□	60P, 90P, 120P	0.7-6.0	26-31	33, 51, 60	30, 60, 90	19.5	19.5, 32, 32
NBT40-SK10C-□	60P, 90P, 120P	1.75-10.0	33-41	32, 45, 48, 73	32, 45, 60, 90	27.5	27.5, 27.5, 40, 40
NBT40-SK10C-150P	150P	1.75-10.0	33-41	73	118	27.5	34, 5
NBT40-SK16C-60P	60P	2.75-16.0	45-52	32	-	40	-
NBT40-SK16C-□	90P, 120P, 150P	2.75-16.0	45-57	43, 58, 88, 118	-	40	-
NBT40-SK20C-60P	60P	3.5-20.0	57-63	32	-	48.5	-
NBT40-SK20C-□	90P, 120P	3.5-20.0	47-63	45, 60, 90	-	48.5	-
NBT50-SK10C-□	105P, 135P	1.75-10.0	33-41	57, 70	57, 92	27.5	27.5, 32
NBT50-SK10C-165P	165P	1.75-10.0	33-41	75	114	27.5	32
NBT50-SK16C-□	105P, 135P	2.75-16.0	45-57	62, 92	-	40	-
NBT50-SK16C-165P	165P	2.75-16.0	45-57	90	112	40	50

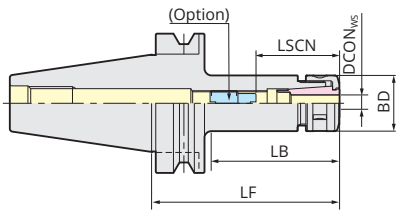

Fig. 1

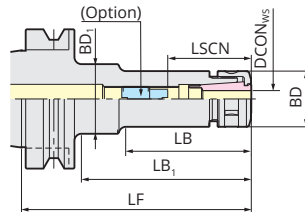

Fig. 2

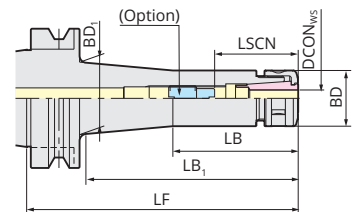

Fig. 3

Max. rpm	Roller Key	Collet	Stop Screw	TiN Clamping Nut (Standard)	Jet Type Clamping Nut	Jet Cover Cap	O-ring Cover Cap	Cover Cap Spanner
40,000	GH6	SK6-□	SKG-8	SKN-6WK(GH)	SKN-6WKJ(GH)	SKJ6-□	SKJ6-□C	SKJL-6
40,000	GH10	SK10-□	SKG-12L	SKN-10K(GH)	SKN-10KJ(GH)	SKJ10-□	SKJ10-□C	SKJL-10
30,000	GH16	SK16-□	SKG-12L	SKN-16B(GH)	SKN-16BJ(GH)	SKJ16-□	SKJ16-□C	SKJL-16
30,000	GH16	SK16-□	SKG-12	SKN-16B(GH)	SKN-16BJ(GH)	SKJ16-□	SKJ16-□C	SKJL-16
30,000	GH16	SK16-□	SKG-18L	SKN-16B(GH)	SKN-16BJ(GH)	SKJ16-□	SKJ16-□C	SKJL-16
30,000	GH20	SK20-□	SKG-12S	SKN-20B(GH)	SKN-20BJ(GH)	SKJ25-□	SKJ25-□C	SKJL-25
30,000	GH20	SK20-□	SKG-12L	SKN-20B(GH)	SKN-20BJ(GH)	SKJ25-□	SKJ25-□C	SKJL-25
30,000	GH20	SK20-□	SKG-12	SKN-20B(GH)	SKN-20BJ(GH)	SKJ25-□	SKJ25-□C	SKJL-25
30,000	GH25	SK25-□	SKG-12	SKN-25B(GH)	SKN-25BJ(GH)	SKJ25-□	SKJ25-□C	SKJL-25
30,000	GH6	SK6-□	SKG-8	SKN-6WK(GH)	SKN-6WKJ(GH)	SKJ6-□	SKJ6-□C	SKJL-6
30,000	GH10	SK10-□	SKG-12L	SKN-10K(GH)	SKN-10KJ(GH)	SKJ10-□	SKJ10-□C	SKJL-10
30,000	GH10	SK10-□	SKG-12L	SKN-10K(GH)	SKN-10KJ(GH)	SKJ10-□	SKJ10-□C	SKJL-10
25,000	GH16	SK16-□	SKG-18S	SKN-16B(GH)	SKN-16BJ(GH)	SKJ16-□	SKJ16-□C	SKJL-16
25,000	GH16	SK16-□	SKG-18L	SKN-16B(GH)	SKN-16BJ(GH)	SKJ16-□	SKJ16-□C	SKJL-16
25,000	GH16	SK16-□	SKG-18L	SKN-16B(GH)	SKN-16BJ(GH)	SKJ16-□	SKJ16-□C	SKJL-16
25,000	GH20	SK20-□	SKG-22	SKN-20B(GH)	SKN-20BJ(GH)	SKJ25-□	SKJ25-□C	SKJL-25
25,000	GH20	SK20-□	SKG-22	SKN-20B(GH)	SKN-20BJ(GH)	SKJ25-□	SKJ25-□C	SKJL-25
20,000	GH10	SK10-□	SKG-12L	SKN-10K(GH)	SKN-10KJ(GH)	SKJ10-□	SKJ10-□C	SKJL-10
20,000	GH10	SK10-□	SKG-12L	SKN-10K(GH)	SKN-10KJ(GH)	SKJ10-□	SKJ10-□C	SKJL-10
20,000	GH16	SK16-□	SKG-18L	SKN-16B(GH)	SKN-16BJ(GH)	SKJ16-□	SKJ16-□C	SKJL-16
20,000	GH16	SK16-□	SKG-18L	SKN-16B(GH)	SKN-16BJ(GH)	SKJ16-□	SKJ16-□C	SKJL-16
40,000	GH6	SK6-□	SKG6-6HG	SKN-6WK(GH)	SKN-6WKJ(GH)	SKJ6-□	SKJ6-□C	SKJL-6
40,000	GH10	SK10-□	SKG10-10HG	SKN-10K(GH)	SKN-10KJ(GH)	SKJ10-□	SKJ10-□C	SKJL-10
30,000	GH16	SK16-□	SKG16-12HGE	SKN-16B(GH)	SKN-16BJ(GH)	SKJ16-□	SKJ16-□C	SKJL-16
30,000	GH16	SK16-□	SKG16-10HG	SKN-16B(GH)	SKN-16BJ(GH)	SKJ16-□	SKJ16-□C	SKJL-16
30,000	GH16	SK16-□	SKG16-12HG	SKN-16B(GH)	SKN-16BJ(GH)	SKJ16-□	SKJ16-□C	SKJL-16
30,000	GH6	SK6-□	SKG6-6HG	SKN-6WK(GH)	SKN-6WKJ(GH)	SKJ6-□	SKJ6-□C	SKJL-6
30,000	GH10	SK10-□	SKG10-10HG	SKN-10K(GH)	SKN-10KJ(GH)	SKJ10-□	SKJ10-□C	SKJL-10
30,000	GH10	SK10-□	SKG10-10HG	SKN-10K(GH)	SKN-10KJ(GH)	SKJ10-□	SKJ10-□C	SKJL-10
25,000	GH16	SK16-□	SKG16-10HG	SKN-16B(GH)	SKN-16BJ(GH)	SKJ16-□	SKJ16-□C	SKJL-16
25,000	GH16	SK16-□	SKG16-12HG	SKN-16B(GH)	SKN-16BJ(GH)	SKJ16-□	SKJ16-□C	SKJL-16
25,000	GH20	SK20-□	SKG20-16HG	SKN-20B(GH)	SKN-20BJ(GH)	SKJ25-□	SKJ25-□C	SKJL-25
25,000	GH20	SK20-□	SKG20-18HG	SKN-20B(GH)	SKN-20BJ(GH)	SKJ25-□	SKJ25-□C	SKJL-25
20,000	GH10	SK10-□	SKG10-10HG	SKN-10K(GH)	SKN-10KJ(GH)	SKJ10-□	SKJ10-□C	SKJL-10
20,000	GH10	SK10-□	SKG10-10HG	SKN-10K(GH)	SKN-10KJ(GH)	SKJ10-□	SKJ10-□C	SKJL-10
20,000	GH16	SK16-□	SKG16-12HG	SKN-16B(GH)	SKN-16BJ(GH)	SKJ16-□	SKJ16-□C	SKJL-16
20,000	GH16	SK16-□	SKG16-12HG	SKN-16B(GH)	SKN-16BJ(GH)	SKJ16-□	SKJ16-□C	SKJL-16

# BT JIS B6339 / MAS 403

MINI MINI CHUCK - BT / NBT / MBT

Overview | Page 16 - 17

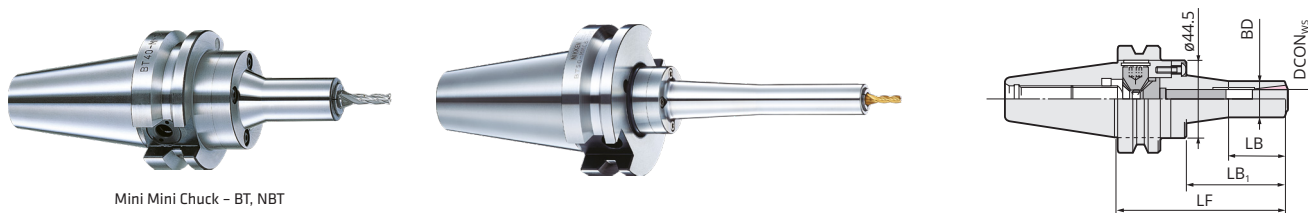

Mini Mini Chuck - BT, NBT

Designation	LF	Diameter	LSCN	LB	LB1
NBT30-MMC8C-105-AA	105	2.0-8.0	9.4-15.0	33	42
NBT30-MMC12C-105-AA	105	4.0-12.0	20.0-31.0	35	44
NBT40-MMC8C-□-AA	90, 120, 150	2.0-8.0	9.4-15.0	33, 40, 40, 70	42, 72, 102, 132
NBT40-MMC12C-□-AA	90, 120, 150	4.0-12.0	20.0-31.0	35, 60, 70, 100	44, 74, 104, 134
NBT50-MMC8C-□-AA	105, 135, 165, 195	2.0-8.0	9.4-15.0	33, 40, 40, 70	42, 72, 102, 132

MAJOR DREAM HOLDER - NBT

Overview | Page 18

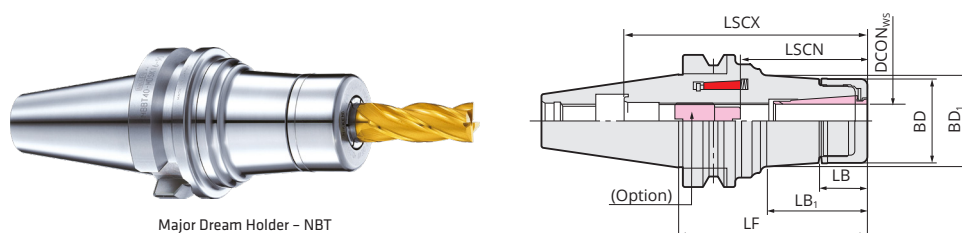

Major Dream Holder - NBT

Designation	LF	Diameter	LSCN	LSCX	LB	LB1	BD
NBT30-MDSK6-□	50, 60, 75, 90	3.0-6.0	21-35	73, 83, 98, 113	16.2	19.5, 25.5, 40.5, 55.5	19.5
NBT30-MDSK10-□	60, 90	3.0-10.0	30-50	72, 82, 97, 112	18	19, 25.7, 42.9, 58.7	27.5
NBT30-MDSK16-75	75	3.0-16.0	45-60	60	23	47.5	40
NBT30-MDSK16-90	90	3.0-16.0	45-70	75	23	62.5	40
NBT40-MDSK6-□	60, 75, 90, 105, 120	3.0-6.0	21-35	86, 101, 116, 131, 146	16.2	18, 33, 48, 63, 78	19.5
NBT40-MDSK10-□	60, 90, 120, 150	3.0-10.0	30-50	86, 101, 116, 131, 146, 176	18	19, 33, 48, 63, 78, 110	27.5
NBT40-MDSK16-65	65	3.0-16.0	45-60	91	23	24	40
NBT40-MDSK16-□	90, 120, 150	3.0-16.0	45-70	101, 116, 131, 146, 176	23	33, 48, 64, 80, 113	40
NBT40-MDSK20-75	75	4.0-20.0	50-73	80	25.2	41.2	48
NBT40-MDSK20-90	90	4.0-20.0	50-73	95	25.2	55	48
NBT40-MDSK20-105	105	4.0-20.0	50-73	110	25.2	70	48
NBT40-MDSK20-120	120	4.0-20.0	50-73	125	25.2	85	48
NBT50-MDSK10-□	105, 120, 135, 165	3.0-10.0	30-50	116, 131, 146, 176, 206	18.2	48, 63.2, 78.2, 110.2, 141.2	27.5
NBT50-MDSK16-□	105, 120, 135, 165	3.0-16.0	45-70	116, 131, 146, 176, 206	23	48, 64, 80.1, 114.7, 144.6	40
NBT50-MDSK20-□	105, 135, 165, 195	4.0-20.0	47-80	159, 175, 205, 235	25.2	42.3, 72, 102, 132	48



Mini Mini Chuck - MBT

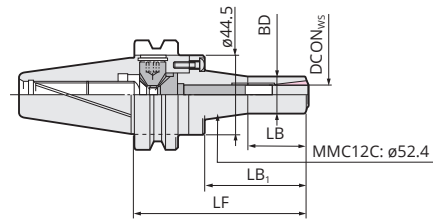

BD	Max. rpm	Collet (Standard)	Collet Metallic Sealing	Jet Collet
20	30,000	PMK8-□	VMK8-□J	VMK8-□
30	30,000	PMK12-□	VMK12-□J	VMK12-□
20	30,000	PMK8-□	VMK8-□J	VMK8-□
30	30,000	PMK12-□	VMK12-□J	VMK12-□
20	20,000	PMK8-□	VMK8-□J	VMK8-□

BD1	Max. rpm	Roller Key	Collet	Stop Screw	Jet Type Clamping Nut	Jet Cover Cap	O-ring Cover Cap	Cover Cap Spanner
20, 20.8, 22.9, 25	40,000	GH6	SK6-□A	SKG-8	MDSKN-6KJ	SKJ6-□	SKJ6-□C	SKJL-6
27.5, 28.6, 31, 33.2	40,000	GH10	SK10-□A	SKG-12L	MDSKN-10KJ	SKJ10-□	SKJ10-□C	SKJL-10
40	40,000	GH16	SK16-□A	SKG-12L	MDSKN-16BJ	SKJ16-□	SKJ16-□C	SKJL-16
40	40,000	GH16	SK16-□A	SKG-12	MDSKN-16BJ	SKJ16-□	SKJ16-□C	SKJL-16
19.5, 21.9, 24, 26.1, 28.2	30,000	GH6	SK6-□A	SKG-8	MDSKN-6KJ	SKJ6-□	SKJ6-□C	SKJL-6
27.5, 29.6, 31.7, 33.8, 35.9, 40.4	30,000	GH10	SK10-□A	SKG-12L	MDSKN-10KJ	SKJ10-□	SKJ10-□C	SKJL-10
40	30,000	GH16	SK16-□A	SKG-18L	MDSKN-16BJ	SKJ16-□	SKJ16-□C	SKJL-16
41.4, 43.5, 45.8, 48, 52.6	30,000	GH16	SK16-□A	SKG-18L	MDSKN-16BJ	SKJ16-□	SKJ16-□C	SKJL-16
51.3	30,000	GH20	SK20-□A	SKG-12	MDSKN-20BJ	SKJ25-□	SKJ25-□C	SKJL-25
53.2	30,000	GH20	SK20-□A	SKG-12-55L	MDSKN-20BJ	SKJ25-□	SKJ25-□C	SKJL-25
52.2	30,000	GH20	SK20-□A	SKG-12-70L	MDSKN-20BJ	SKJ25-□	SKJ25-□C	SKJL-25
53.2	30,000	GH20	SK20-□A	SKG-12-85L	MDSKN-20BJ	SKJ25-□	SKJ25-□C	SKJL-25
31, .7, 33.8, 35.9, 40.4, 44.8	20,000	GH10	SK10-□A	SKG-12L	MDSKN-10KJ	SKJ10-□	SKJ10-□C	SKJL-10
43.5, 45.8, 48, 52.6, 52.8	20,000	GH16	SK16-□A	SKG-18L	MDSKN-16BJ	SKJ16-□	SKJ16-□C	SKJL-16
51.4, 55.6, 59.8, 64	20,000	GH20	SK20-□A	SKG-22	MDSKN-20BJ	SKJ25-□	SKJ25-□C	SKJL-25

# BT JIS B6339 / MAS 403

MULTI-LOCK MILLING CHUCK - BT / NBT / MBT

Overview | Page 8 - 15



Multi-Lock Milling Chuck - BT

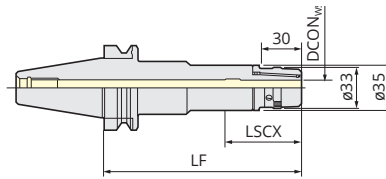

Multi-Lock Milling Chuck C12

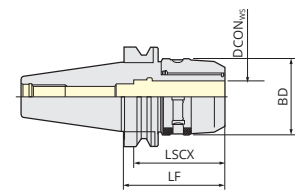

Designation	LF	Diameter	LSCN	LSCX	BD	Max. rpm
BT30-C16-55	55	2.0-16.0	47.5	65	44	10,000
BT30-C20-65	65	2.0-20.0	53	80	52	6,000
BT30-C25-75	75	3.0-25.0	59	68	55	5,000
BT40-C20-□	70, 90, 120	2.0-20.0	53	80	52	7,000
BT40-C25-□	70, 90, 120	3.0-25.0	59	80	60	6,000
BT40-C32-120	120	3.0-32.0	64.5	77, 90, 105	69	6,000
BT50-C20-□	105, 135, 165	2.0-20.0	53	80	52	8,000
BT50-C25-□	105, 135, 165	3.0-25.0	59	80	60	8,000
BT50-C32-□	90, 105, 120, 135, 165	3.0-32.0	64.5	105	69	6,000
NBT30-C12-55	55	2.0-12.0	40	58	33	15,000
NBT30-C16-□	55, 70	2.0-16.0	47.5	65	44	10,000
NBT30-C20-□	65, 75	2.0-20.0	53	80	52	6,000
NBT30-C25-□	75, 90	3.0-25.0	59	68, 68, 80	55	6,000
NBT30-C32-100	100	3.0-32.0	64.5	68, 72	64	5,000
NBT40-C20-□	70, 90, 120	2.0-20.0	53	80	52	7,000
NBT40-C25-□	70, 90, 120	3.0-25.0	59	80	60	6,000
NBT40-C32-□	85, 105, 120, 135	3.0-32.0	64.5	77, 81, 81, 81	69	6,000
NBT50-C20-□	105, 135, 165	2.0-20.0	53	80	52	8,000
NBT50-C25-□	105, 135, 165	3.0-25.0	59	80	60	8,000
NBT50-C32-□	105, 120, 135, 165	3.0-32.0	64.5	81	69	6,000

Clamping Key	Collet	Jet Cover Cap	O-ring Cover Cap	Cover Cap Spanner
9HC16	CCK16-□, KM16-□	CKFN16-□	CKFN16-□C	CCKLN16
9HC22	CCK20-□, CCNK20-□, KM20-□, NK20-□	CKFN20-□	CKFN20-□C	CCKLN20
9HC22	CCK25-□, CCNK25-□, KM25-□, NK25-□	CKFN25-□	CKFN25-□C	CCKLN25
9HC22	CCK20-□, CCNK20-□, KM20-□, NK20-□	CKFN20-□	CKFN20-□C	CCKLN20
9HC25	CCK25-□, CCNK25-□, KM25-□, NK25-□	CKFN25-□	CKFN25-□C	CCKLN25
9HC32	CCK32-□, CCNK32-□, KM32-□, NK32-□	CKFN32-□	CKFN32-□C	CCKLN32
9HC22	CCK20-□, CCNK20-□, KM20-□, NK20-□	CKFN20-□	CKFN20-□C	CCKLN20
9HC25	CCK25-□, CCNK25-□, KM25-□, NK25-□	CKFN25-□	CKFN25-□C	CCKLN25
9HC32	CCK32-□, CCNK32-□, KM32-□, NK32-□	CKFN32-□	CKFN32-□C	CCKLN32
9HC12A	CCK12-□, KM12-□	CKFN12-□	CKFN12-□C	CCKLN12
9HC16	CCK16-□, KM16-□	CKFN16-□	CKFN16-□C	CCKLN16
9HC22	CCK20-□, CCNK20-□, KM20-□, NK20-□	CKFN20-□	CKFN20-□C	CCKLN20
9HC22	CCK25-□, CCNK25-□, KM25-□, NK25-□	CKFN25-□	CKFN25-□C	CCKLN25
9HC25	CCK32-□, CCNK32-□, KM32-□, NK32-□	CKFN32T-□	CKFN32-□C	CCKLN32
9HC22	CCK20-□, CCNK20-□, KM20-□, NK20-□	CKFN20-□	CKFN20-□C	CCKLN20
9HC25	CCK25-□, CCNK25-□, KM25-□, NK25-□	CKFN25-□	CKFN25-□C	CCKLN25
9HC32	CCK32-□, CCNK32-□, KM32-□, NK32-□	CKFN32-□	CKFN32-□C	CCKLN32
9HC22	CCK20-□, CCNK20-□, KM20-□, NK20-□	CKFN20-□	CKFN20-□C	CCKLN20
9HC25	CCK25-□, CCNK25-□, KM25-□, NK25-□	CKFN25-□	CKFN25-□C	CCKLN25
9HC32	CCK32-□, CCNK32-□, KM32-□, NK32-□	CKFN32-□	CKFN32-□C	CCKLN32



# BT JIS B6339 / MAS 403

HIGH SPEED MULTI-LOCK MILLING CHUCK - BT / NBT / MBT

Overview | Page 19 - 24

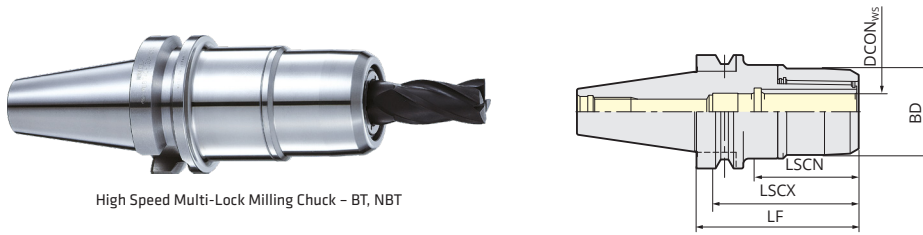

High Speed Multi-Lock Milling Chuck - BT, NBT

Designation	LF	Diameter	LSCN	LSCX	BD	Max. rpm	Roller Key
BT30-C16-55G	55G	2.0-16.0	47.5	65	40	40,000	GH16
BT30-C20-□	65G, 75G	2.0-20.0	53	80	48	30,000	GH20
BT30-C25-□	75G, 80G	3.0-25.0	59	68	55	25,000	GH25
BT30-C32-□	90G, 100G	3.0-32.0	64.5	68, 76	62	10,000	GH32S
BT40-C20-□	70G, 90G	2.0-20.0	53	80	48	25,000	GH20
BT40-C25-□	70G, 90G	3.0-25.0	59	80	55	20,000	GH25
BT40-C32-□	85G, 105G	3.0-32.0	64.5	77, 90	68	20,000	GH32
BT50-C20-□	105G, 135G	2.0-20.0	53	80	48	20,000	GH20
BT50-C25-□	105G, 135G	3.0-25.0	59	80	55	15,000	GH25
NBT30-C12-55G	55G	2.0-12.0	40	58	33	40,000	GH12
NBT30-C16-55G-□	55G, 70G	2.0-16.0	47.5	65	40	40,000	GH16
NBT30-C20-65G	65G	2.0-20.0	53	80	48	30,000	GH20
NBT30-C25-□	75G, 90G	3.0-25.0	59	68, 68, 80	55	25,000	GH25
NBT40-C20-□	70G, 90G, 105G, 120G	2.0-20.0	53	80	48	25,000	GH20
NBT40-C25-□	70G, 90G, 120G	3.0-25.0	59	80	55	20,000	GH25
NBT50-C20-□	105G, 135G	2.0-20.0	53	80	48	20,000	GH20
NBT50-C25-□	105G, 135G, 165G	3.0-25.0	59	80	55	15,000	GH25



High Speed Multi-Lock Milling Chuck - MBT

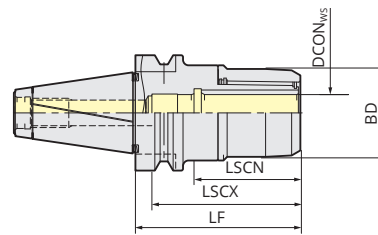

Collet	Jet Cover Cap	O-ring Cover Cap	Stop Screw	Cover Cap Spanner
CCK16-□, KM16-□	CKFN16-□	CKFN16-□C	-	CCKLN16
CCK20-□, CCNK20-□, KM20-□, NK20-□	CKFN20-□	CKFN20-□C	9MC20H	CCKLN20
CCK25-□, CCNK25-□, KM25-□, NK25-□	CKFN25-□	CKFN25-□C	9MC25H	CCKLN25
CCK32-□, CCNK32-□, KM32-□, NK32-□	CKFN32T-□	CKFN32-□C	9MC32H	CCKLN32
CCK20-□, CCNK20-□, KM20-□, NK20-□	CKFN20-□	CKFN20-□C	9MC20H	CCKLN20
CCK25-□, CCNK25-□, KM25-□, NK25-□	CKFN25-□	CKFN25-□C	9MC25H	CCKLN25
CCK32-□, CCNK32-□, KM32-□, NK32-□	CKFN32-□	CKFN32-□C	9MC32H	CCKLN32
CCK20-□, CCNK20-□, KM20-□, NK20-□	CKFN20-□	CKFN20-□C	-	CCKLN20
CCK25-□, CCNK25-□, KM25-□, NK25-□	CKFN25-□	CKFN25-□C	-	CCKLN25
CCK12-□, KM12-□	CKFN12-□	CKFN12-□C	-	CCKLN12
CCK16-□, KM16-□	CKFN16-□	CKFN16-□C	-	CCKLN16
CCK20-□, CCNK20-□, KM20-□, NK20-□	CKFN20-□	CKFN20-□C	9MC20H	CCKLN20
CCK25-□, CCNK25-□, KM25-□, NK25-□	CKFN25-□	CKFN25-□C	9MC25H	CCKLN25
CCK20-□, CCNK20-□, KM20-□, NK20-□	CKFN20-□	CKFN20-□C	9MC20H	CCKLN20
CCK25-□, CCNK25-□, KM25-□, NK25-□	CKFN25-□	CKFN25-□C	9MC25H	CCKLN25
CCK20-□, CCNK20-□, KM20-□, NK20-□	CKFN20-□	CKFN20-□C	9MC20H	CCKLN20
CCK25-□, CCNK25-□, KM25-□, NK25-□	CKFN25-□	CKFN25-□C	9MC25H	CCKLN25

# BT JIS B6339 / MAS 403

ZERO FIT SLIM CHUCK – BT / NBT / MBT

Overview | Page 25 - 27

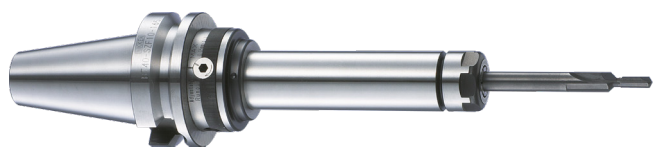

Zero Fit Slim Chuck – BT, NBT

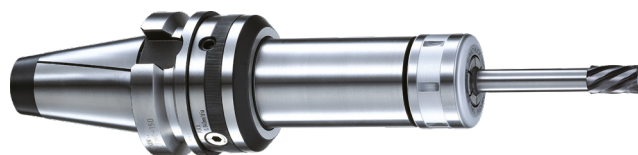

Zero Fit Slim Chuck – MBT

Designation	LF	Diameter	LSCN	LB	LB1	BD	BD1	Max. rpm	Clamping Key
BT30-SZF6-90	90	0.7-6.0	21-35	42	-	19.5	40.5	15,000	SKL-6W
BT30-SZF10-90	90	1.75-10.0	30-50	35	61	27.5	48.5	15,000	SKL-10
BT30-SZF16-105	105	2.75-16.0	45-65	40	76	40	59.5	10,000	9HC16
BT40-SZF6-□	90, 150	0.7-6.0	21-35	37, 60	-	19.5	40.5, 48.5	15,000	SKL-6W
BT40-SZF10-□	90, 150	1.75-10.0	30-50	37, 97	-	27.5	48.5	15,000	SKL-10
BT40-SZF16-□	90, 150	2.75-16.0	45-65	37, 97	-	40	59.5	12,000	9HC16
BT40-SZF25-□	120, 150	7.5-25.4	55-85	55, 86	84, 114	55	66.5	10,000	9HC25
BT50-SZF6-□	105, 165	0.7-6.0	21-35	41, 63	-	19.5	40.5, 59.5	15,000	SKL-6W
BT50-SZF10-□	105, 165	1.75-10.0	30-50	41, 101	-	27.5	48.5	15,000	SKL-10
BT50-SZF16-□	105, 165	2.75-16.0	45-65	41, 101	-	40	59.5	12,000	9HC16
BT50-SZF25-□	135, 165	7.5-25.4	55-85	71, 101	-	55	66.5	10,000	9HC25

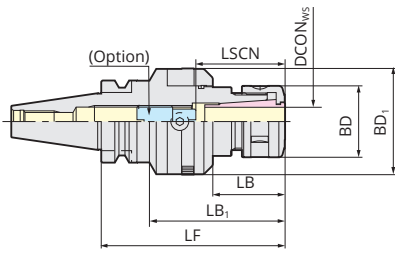

Fig. 1

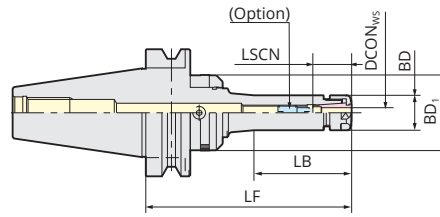

Fig. 2

Collet	Stop Screw	TiN Clamping Nut (Standard)	Jet Type Clamping Nut	Jet Cover Cap	O-ring Cover Cap	Cover Cap Spanner	Fig.
SK6-□	SKG-8	SKN-6WK	SKN-6WKJ	SKJ6-□	SKJ6-□C	SKJL-6	2
SK10-□	SKG-12L	SKN-10K	SKN-10KJ	SKJ10-□	SKJ10-□C	SKJL-10	1
SK16-□	SKG-28	SKN-16B	SKN-16BJ	SKJ25-□	SKJ25-□C	SKJL-25	1
SK6-□	SKG-8	SKN-6WK	SKN-6WKJ	SKJ6-□	SKJ6-□C	SKJL-6	2
SK10-□	SKG-12L	SKN-10K	SKN-10KJ	SKJ10-□	SKJ10-□C	SKJL-10	2
SK16-□	SKG-18L	SKN-16B	SKN-16BJ	SKJ16-□	SKJ16-□C	SKJL-16	2
SK25-□	SKG-28	SKN-25B	SKN-25BJ	SKJ25-□	SKJ25-□C	SKJL-25	1
SK6-□	SKG-8	SKN-6WK	SKN-6WKJ	SKJ6-□	SKJ6-□C	SKJL-6	2
SK10-□	SKG-12L	SKN-10K	SKN-10KJ	SKJ10-□	SKJ10-□C	SKJL-10	2
SK16-□	SKG-18L	SKN-16B	SKN-16BJ	SKJ16-□	SKJ16-□C	SKJL-16	2
SK25-□	SKG-28	SKN-25B	SKN-25BJ	SKJ25-□	SKJ25-□C	SKJL-25	2

# BT JIS B6339 / MAS 403

ZERO FIT MULTI-LOCK - BT / NBT / MBT

Overview | Page 25 - 27

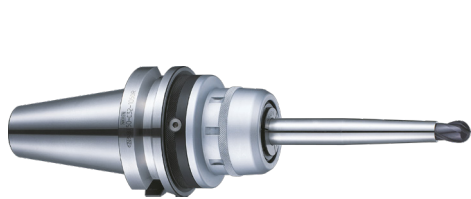

Zero Fit Multi-Lock - BT, NBT

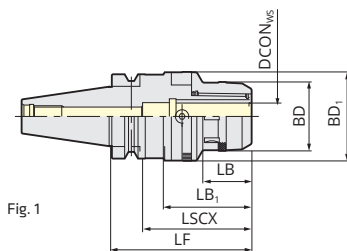

Fig. 1

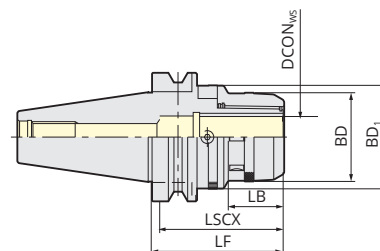

Fig. 2

Designation	LF	Diameter	LSCN	LSCX	LB	LB1	BD	BD1	Max. rpm
BT30-CZF20-100	100	2.0-20.0	53	80	35	68	51.5	66.5	6,000
BT30-CZF25-100	100	3.0-25.0	59	80	35	68	59.5	74.5	5,000
BT40-CZF20-□	105, 120	2.0-20.0	53	80	35	64.5	51.5	66.5	7,000
BT40-CZF25-□	105, 120	3.0-25.0	59	80	35	68	59.5	74.5	6,000
BT40-CZF32-120	120	3.0-32.0	64.5	105	42	78	69	80.5	6,000
BT50-CZF20-□	105, 165	2.0-20.0	53	80	35	-	51.5	66.5	8,000
BT50-CZF25-□	105, 165	3.0-25.0	59	80	35	-	59.5	74.5	8,000
BT50-CZF32-□	105, 165	3.0-32.0	64.5	105	42	-	69	80.5	6,000

# BT FMH Face Mill Arbor



FMH

■ For Oil Hole Cutter  
For High Speed Cutter

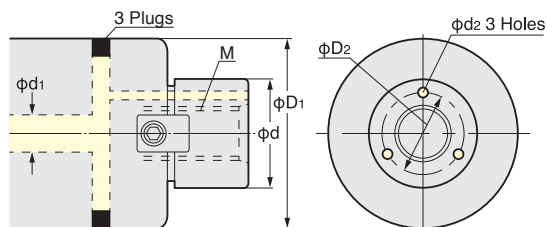
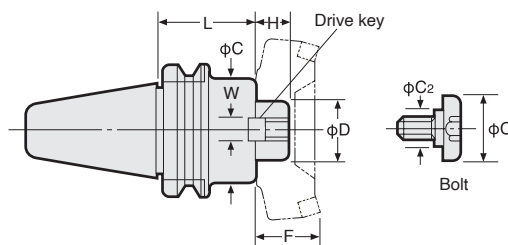

Code No.	Cutter Dia.	φd	φD1	M	Coolant Hole		
					φD2	φd1	φd2
FMH16	φ40	16	37	M8 P1.25	12	6	2
FMH22	φ50, φ52	22	47	M10 P1.5	16	6 ~ 8	3
	φ63, φ66						
FMH27	φ80	27	60, 76	M12 P1.75	18.5	8 ~ 10	3.5



Zero Fit Multi-Lock - MBT

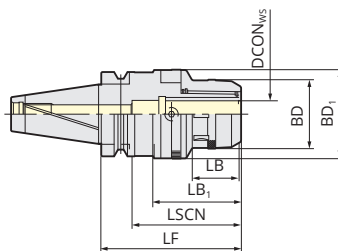

Fig. 1

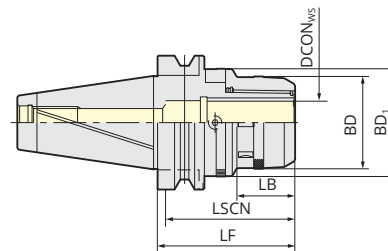

Fig. 2

Clamping Key	Collet	Jet Cover Cap	O-ring Cover Cap	Cover Cap Spanner	Fig.
9HC22	CCK20-□, KM20-□	CKFN20-□	CKFN20-□C	CCKLN20	1
9HC25	CCK25-□, KM25-□	CKFN25-□	CKFN25-□C	CCKLN25	1
9HC22	CCK20-□, KM20-□	CKFN20-□	CKFN20-□C	CCKLN20	1
9HC25	CCK25-□, KM25-□	CKFN25-□	CKFN25-□C	CCKLN25	1
9HC32	CCK32-□, KM32-□	CKFN32-□	CKFN32-□C	CCKLN32	1
9HC22	CCK20-□, KM20-□	CKFN20-□	CKFN20-□C	CCKLN20	2
9HC25	CCK25-□, KM25-□	CKFN25-□	CKFN25-□C	CCKLN25	2
9HC32	CCK32-□, KM32-□	CKFN32-□	CKFN32-□C	CCKLN32	2

### FMH Metric Series

Code No.	Arbor			C	C1	W	Drive Key	Lock Bolt	G Cap Bolt	Weight (kg)
	D	L	H							
BT30-FMH16- 37 - 35	16	35	17	37	20	8	FW 3	FM 8	-	0.56
-FMH22- 47 - 45	22	45	18	47	16	10	FW 8	-	9GM10-30	0.76
-FMH27- 60 - 45	27	45	20	60	18	12	FW 11	-	9GM12-35	0.91
BT40-FMH16- 37 - 40	16	40	17	37	20	8	FW 3	FM 8	-	1.1
(IT40)-FMH22- 47 - 45	22	45	18	47	16	10	FW 8	-	9GM10-30	1.3
- 60		60								1.5
-FMH22- 60 - 45*1	22	45	18	60	16	10	FW 8	-	9GM10-30	1.5
- 60		60								1.8
-FMH27- 60 - 45	27	45	20	60	18	12	FW 11	-	9GM12-35	1.5
- 60		60								1.8
-FMH27- 76 - 60	27	60	20	76	18	12	FW 11	-	9GM12-35	2.1
- 90		90								2.8
BT50-FMH16- 37 - 60	16	60	17	37	20	8	FW 3	FM 8	-	3.8
(IT50)	-105	105								4.1
-FMH22- 47 - 60	22	60	18	47	16	10	FW 8	-	9GM10-30	4.1
- 105		105								4.7
-FMH22- 60 - 60	22	60	18	60	16	10	FW 8	-	9GM10-30	4.2
- 105		105								5.2
-FMH27- 60 - 45	27	45	20	60	18	12	9FWE27	-	9GM12-35	3.9
- 90		90					FW 8			5.0
-FMH27- 76 - 45	27	45	20	76	18	12	FW 10	-	9GM12-35	4.0
- 90		90					FW 11			5.6

\*1IT40-FMH27-60-45 is not available.



# Polygon Shank ISO 26223-1

SLIM CHUCK – POLYGON SHANK

Overview | Page 8 - 15

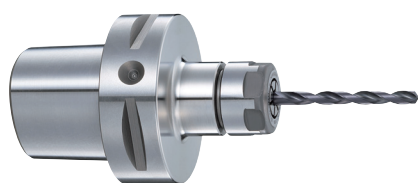

Slim Chuck

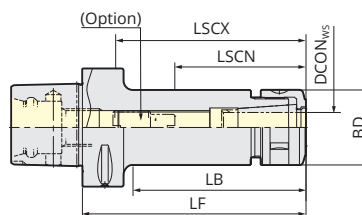

Designation	LF	Diameter	LSCN	LB	BD	Max. rpm	Clamping Key
C4-SK6-60	60	0.7-6.0	30	40	19.5	15,000	SKL-6W
C4-SK10-60	60	1.75-10.0	35.1	40	27.5	15,000	SKL-10
C4-SK16-60	60	2.75-16.0	51.3	39.3	40	15,000	9HC16
C4-SK20-75	75	3.5-20.0	61	55	48.5	12,000	9HC22
C6-SK6-□	60, 90, 120	0.7-6.0	21-35	33, 63, 88	19.5	15,000	SKL-6W
C6-SK10-□	60, 90, 120	1.75-10.0	30-51	33, 63, 93	27.5	15,000	SKL-10
C6-SK16-□	60, 90, 120	2.75-16.0	40-70	35, 63, 93	40	15,000	9HC16
C6-SK20-□	70, 90, 120	3.5-20.0	47-80	45, 65, 95	48.5	12,000	9HC22
C8-SK10-□	120, 165	1.75-10.0	30-50	50, 75, 120	27.5	15,000	SKL-10
C8-SK16-□	120, 165	2.75-16.0	40-70	50, 80, 125	40	15,000	9HC16
C8-SK20-□	120, 165	3.5-20.0	47-80	50, 80, 125	48.5	12,000	9HC22

MULTI-LOCK MAJOR DREAM – POLYGON SHANK

Overview | Page 18



Multi-Lock Major Dream

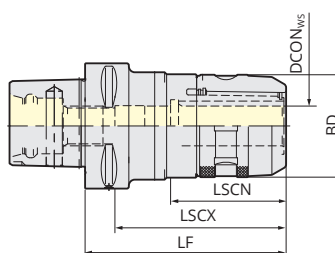

Designation	LF	Diameter	LSCN	BD	Max. rpm	Clamping Key
C6-MDC20-100	100	2.0-20.0	57	52	8,000	9HC22
C6-MDC25-110	110	3.0-25.0	58	60	8,000	9HC25
C6-MDC32-130	130	3.0-32.0	70	68	8,000	9HC32

Collet	Stop Screw	TiN Clamping Nut (Standard)	Jet Type Clamping Nut	Jet Cover Cap	O-ring Cover Cap	Cover Cap Spanner
SK6-□	SKG6-6HG	SKN-6WK	SKN-6WKJ	SKJ6-□	SKJ6-□C	SKJL-6
SK10-□	SKG10-10HG	SKN-10K	SKN-10KJ	SKJ10-□	SKJ10-□C	SKJL-10
SK16-□	SKG16-12HG	SKN-16B	SKN-16BJ	SKJ16-□	SKJ16-□C	SKJL-16
SK20-□	SKG20-12MFHG	SKN-20B	SKN-20BJ	SKJ25-□	SKJ25-□C	SKJL-25
SK6-□	SKG6-6HG	SKN-6WK	SKN-6WKJ	SKJ6-□	SKJ6-□C	SKJL-6
SK10-□	SKG10-10HG	SKN-10K	SKN-10KJ	SKJ10-□	SKJ10-□C	SKJL-10
SK16-□	SKG16-12HG	SKN-16B	SKN-16BJ	SKJ16-□	SKJ16-□C	SKJL-16
SK20-□	SKG20-12MFHG	SKN-20B	SKN-20BJ	SKJ25-□	SKJ25-□C	SKJL-25
SK10-□	SKG10-10HG	SKN-10K	SKN-10KJ	SKJ10-□	SKJ10-□C	SKJL-10
SK16-□	SKG16-12HG	SKN-16B	SKN-16BJ	SKJ16-□	SKJ16-□C	SKJL-16
SK20-□	SKG20-12MFHG	SKN-20B	SKN-20BJ	SKJ25-□	SKJ25-□C	SKJL-25

Collet	Jet Cover Cap	O-ring Cover Cap	Cover Cap Spanner
CCK20-□, CCNK20-□, KM20-□, NK20-□	CKFN20-□	CKFN20-□C	CCKLN20
CCK25-□, CCNK25-□, KM25-□, NK25-□	CKFN25-□	CKFN25-□C	CCKLN25
CCK32-□, CCNK32-□, KM32-□, NK32-□	CKFN32-□	CKFN32-□C	CCKLN32

# Polygon Shank ISO 26223-1

MAJOR DREAM HOLDER - POLYGON SHANK

Overview | Page 18

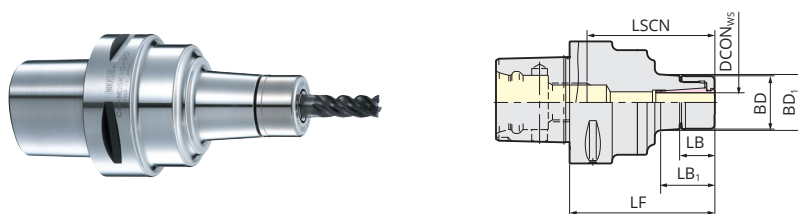

Major Dream Holder

Designation	LF	Diameter	LSCN	LB	LB1	BD	BD1	Max. rpm	Roller Key
C6-MDSK10-□	65, 90	3.0-10.0	30-50	18.2	19.43	27.5	27.5, 31	20,000	GH10
C6-MDSK16-□	70, 90	3.0-16.0	45-60	22	24.43	40	40, 42.8	20,000	GH16
C6-MDSK20-□	80, 90	4.0-20.0	47-70	25.2	39.3, 50.7	48	51, 52.6	20,000	GH20

STANDARD MULTI-LOCK MILLING CHUCK - POLYGON SHANK

Overview | Page 19 - 24



Standard Multi-Lock Milling Chuck

Designation	LF	Diameter	LSCN	LSCX	BD	Max. rpm	Clamping Key
C6-C20-□	75, 90, 120	2.0-20.0	66	66, 80, 80	52	8,000	9HC22
C6-C25-□	75, 90, 120,	3.0-25.0	66	66, 80, 80	60	8,000	9HC25
C6-C32-□	80, 120	3.0-32.0	71	71, 107	69	6,000	9HC32
C8-C20-□	105, 135, 165	2.0-20.0	58	80	52	8,000	9HC22
C8-C25-□	75, 105, 135, 165	3.0-25.0	60	80	60	8,000	9HC25
C8-C32-□	90, 105, 135, 165	3.0-32.0	70	100, 105, 105, 105	69	6,000	9HC32

# Straight Shank

MINI MINI CHUCK - STRAIGHT SHANK

Overview | Page 16 - 17



Mini Mini Chuck

Designation	OAL	DCONMS	LB1	LB2	Diameter	LSCN	BD
K20-MMC-8-100	100	20	80	20	2.0-8.0	9.4-15.0	20
K32-MMC8-□	122, 160	32	67	40	2.0-8.0	9.4-15.0	20
K32-MMC12-170S	170	32	120	50	4.0-12.0	20.0-31.0	30

Collet	Stop Screw	Jet Type Clamping Nut	Jet Cover Cap	O-ring Cover Cap	Cover Cap Spanner
SK10-□A	SKG-12L	MDSKN-10KJ	SKJ10-□	SKJ10-□C	SKJL-10
SK16-□A	SKG-18S	MDSKN-16BJ	SKJ16-□	SKJ16-□C	SKJL-16
SK20-□A	SKG20-22	MDSKN-20BJ	SKJ20-□	SKJ20-□C	SKJL-25

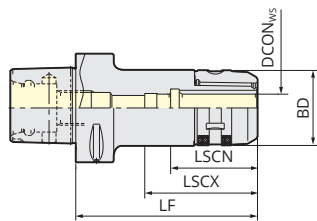

Fig. 1

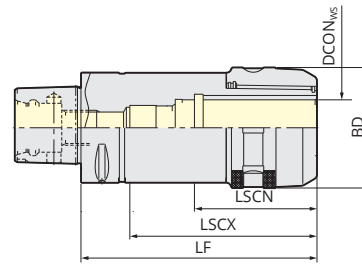
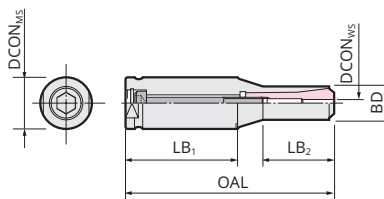

Fig. 2

Collet	Jet Cover Cap	O-ring Cover Cap	Cover Cap Spanner
CCK20-□, CCNK20-□, KM20-□, NK20-□	CKFN20-□	CKFN20-□C	CCKLN20
CCK25-□, CCNK25-□, KM25-□, NK25-□	CKFN25-□	CKFN25-□C	CCKLN25
CCK32-□, CCNK32-□, KM32-□, NK32-□	CKFN32-□	CKFN32-□C	CCKLN32
CCK20-□, CCNK20-□, KM20-□, NK20-□	CKFN20-□	CKFN20-□C	CCKLN20
CCK25-□, CCNK25-□, KM25-□, NK25-□	CKFN25-□	CKFN25-□C	CCKLN25
CCK32-□, CCNK32-□, KM32-□, NK32-□	CKFN32-□	CKFN32-□C	CCKLN32

Optionally, all holders can be ordered in the "High Speed" version. Insert the designation "P" at the end.



Collet (Standard)	Jet Collet	Collet Metallic Sealing	Weight (kg)
PMK8-□	VMK8-□J	VMK8-□	0.2
PMK8-□	VMK8-□J	VMK8-□	0.5, 0.7
PMK12-□	VMK12-□J	VMK12-□	1

# Accessories

## TILTING ASSEMBLY SUPPORT

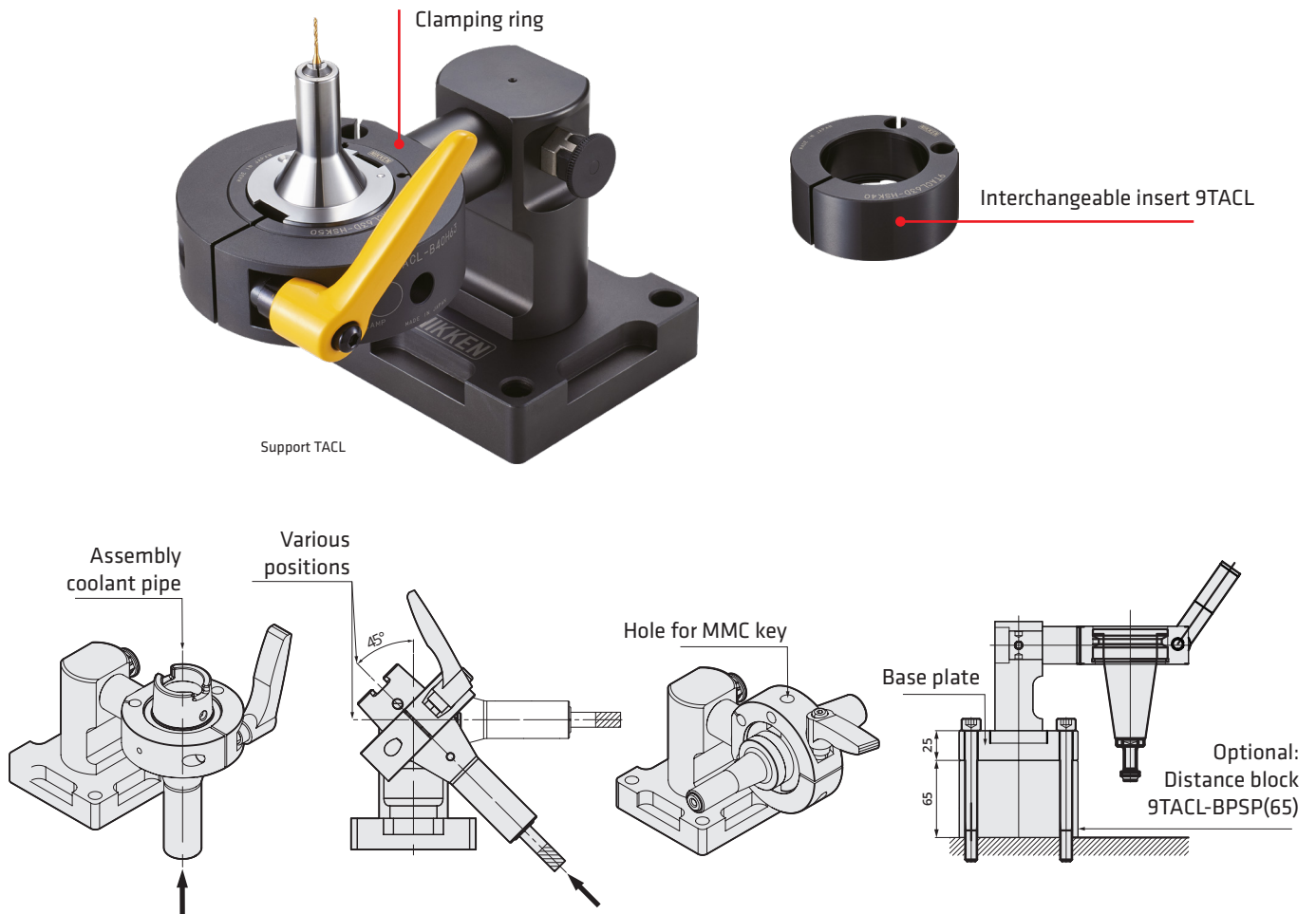

Support Designation	HSK63	HSK100	IT40	BT40	BT50	C6
TACL-B40H63	○	-	-	○	-	○
TACL-B50H100	-	○	-	-	○	-
TACL-ICAT40	-	-	○	-	-	-

TACL-B40H63 available inserts	Shaft Standard
9TACL63D-B30N46	BT30
9TACL63D-HSK40	HSK40, C4
9TACL63D-HSK32	HSK32
9TACL63D-HSK25	HSK25

TACL-B50H100 available inserts	Shaft Standard
9TACL100D-B40H63	BT40 HSK63, C6
9TACL100D-IT50	IT50
9TACL100D-HSK80	HSK80, C8

TACL-B40H63 available inserts	Shaft Standard
9TACL63D-S5/8	K5/8CM
9TACL63D-S3/4	K3/4CM, ST3/4
9TACL63D-S20	K20CM, ST20
9TACL63D-S25	K25CM, ST25
9TACL63D-S1	K1CM, ST1

## CLAMPING KEY

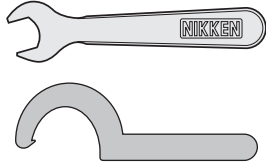

Milling Chuck	Designation	Slim Chuck	Designation
C20	9HC22	SK6 (C=Ø 18mm)	SKL-6
C25 (C1=Ø 55mm)	9HC22	SK6 (C=Ø 19.5mm)	SKL-6W
C25 (C1=Ø 60mm)	9HC25	SK10	SKL-10
C32 (C1=Ø 64mm)	9HC25	SK16	9HC16
C32 (C1=Ø 69mm)	9HC32	SK20	9HC22

## ROLLER KEY

The GH Roller Key has a switch lever for releasing / clamping. This makes it easy to change tools.



Designation	Milling Chuck	Slim Chuck	Major Dream	VC Holder
GH6*	–	SK 6-P / SKT 6	MDSK 6	–
GH10*	–	SK10-P / SKT10	MDSK10	VC6
GH16*	–	SK16-P / SKT16	MDSK16	–
GH20*	C20-G	SK20-P / SKT20	MDSK20	–
GH25*	C25-G	SK25-P / SKT25	MDSK25	–
GH32S	C32-G (Clamping nut: Ø 62mm)	–	–	–
GH32	C32-G (Clamping nut: Ø 68mm)	–	–	–

\* The models are optionally available with torque adjustment: GH6-TLS, GH10-TLS, GH16-TLS, GH20-TLS, GH25-TLS

## HSK COOLANT PIPE



Size	Coolant Pipe Designation		Wrench Code
	Moveable	Tight	
HSK40A	HSK40-LP	HSK40-LPS	HSK40-LPL
HSK63A	HSK63-LP	HSK63-LPS	HSK63-LPL
HSK100A	HSK100-LP	HSK100-LPS	HSK100-LPL

Screw plug for HSK63 - HSK63-LPGP optionally available



## ADJUSTING SCREWS

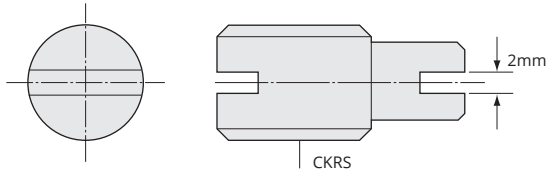

Fig. 1

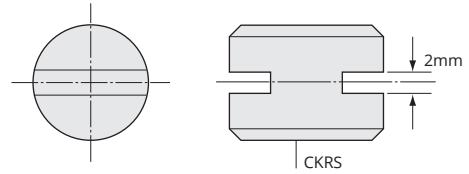
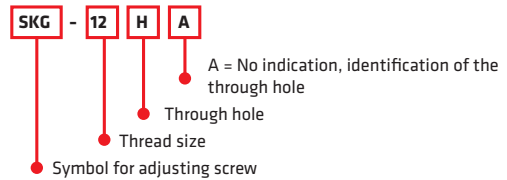
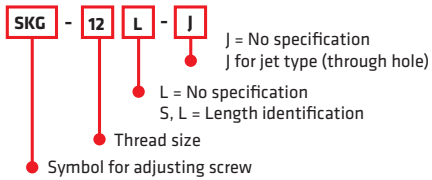

Fig. 2

Type	CKRS	Adjusting screw	Fig.	Slim Chuck Designation
SK6	M6	SKG- 8	1	All SK6 Slim Chucks
SK10	M12	SKG-12L	1	All SK10 Slim Chucks except for:
		SKG-12S	2	HSK50A-SK10-90, HSK63F-SK10-90
SK16	M18x1.5	SKG-18L	1	All SK16 Slim Chucks except for:
		SKG-12	2	BT30-SK16-90
	M12	SKG-12L	1	BT30-SK16-60
		SKG-18S	2	BT40-SK16-60
SK20	M22x1.5	SKG-22	1	All SK20 Slim Chucks except for:
		SKG-12	2	BT30-SK20-90
	M12	SKG-12L	1	BT30-SK20-75
		SKG-12S	2	BT30-SK20-60

Type	CKRS	Adjusting screw	Fig.	CND	Wkz ø
SK10	M12	SKG-12H	3	ø 4	ø 6-
		SKG-12HA	3	ø 2.5	ø 4-
SK16	M12	SKG-12H	3	ø 4	ø 6-
		SKG-12HA	3	ø 2.5	ø 4-
	M18x1.5	SKG-18H	3	ø 7.2	ø 10-
SK20	M12	SKG-12H	3	ø 4	ø 6-
		SKG-12HA	3	ø 2.5	ø 4-
	M22x1.5	SKG-22H	3	ø 8	ø 10-

All models can be ordered with a through hole.  
Add J at the end of the designation.



Other versions, for example for use in thread cutting thread cutting, are available on request.

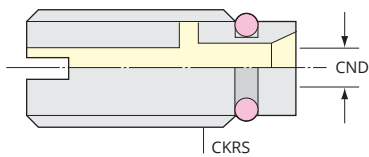

Fig. 3

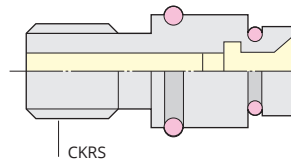
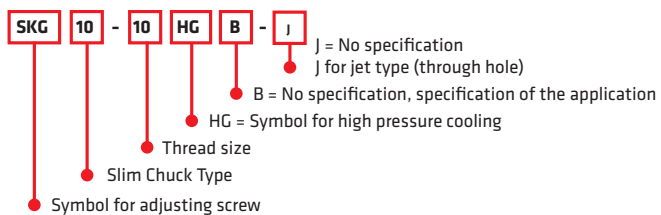

Fig. 4

Type	CKRS	Adjusting screw	Fig.	CND	WKz ø	Slim Chuck Designation
<b>SK6</b>	M6	SKG 6- 6HG	4	ø 2.5	ø 4-	All Slim Chucks SK6C/SK6F
<b>SK10</b>	M10	SKG10-10HG	4	ø 4	ø 6-	All Slim Chucks SK10C/SK10F
	M10	SKG10-10HGA	4	ø 2.5	ø 4-	
<b>SK16</b>	M12	SKG16-12HG	4	ø 7.2	ø 10-	All Slim Chucks SK16C/SK16F, except for:
	M12	SKG16-12HGB	4			BT40-SK16F-90
	M10	SKG16-10HG	4			HSK40A-SK16C-120, HSK50A-SK16C-120 HSK63A-SK16C-120, 150, HSK100A-SK16C-120 NBT40-SK16C-60
	M12	SKG16-12HGE	4			NBT30-SK16C-60
<b>SK16</b>	M12	SKG16-12HGA	4	ø 3.5	ø 5-	All Slim Chucks SK16C/SK16F, except for:
	M12	SKG16-12HGBA	4			BT40-SK16F-90
	M10	SKG16-10HGA	4			HSK40A-SK16C-120, HSK50A-SK16C-120 HSK63A-SK16C-120, 150, HSK100A-SK16C-120 NBT40-SK16C-60, NBT30-SK16C-75
	M12	SKG16-12HGE	4			NBT30-SK16C-60
<b>SK20</b>	M18x1.5	SKG20-18HG	4	ø 6.8	ø 10-	All Slim Chucks SK20C/SK20F, except for:
	M12	SKG20-12MFHG	4			HSK63A-SK20C-120, -135
	M12	SKG20-12HG	4			NBT30-SK20C-90 HSK100A-SK20C-150, -200
	M10	SKG20-12HGE	4			NBT30-SK20C-75
	M16	SKG20-16HG	4			NBT40-SK20C-60
	M18x1.5	SKG20-18HGB	4			BT40-SK20F-90



# Spindle Connections

## DIMENSION OF ISO, DIN & MAS BT SHAFT

HSK25E (DIN69893-5)

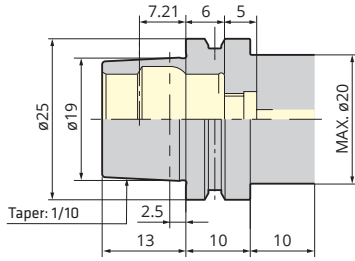

HSK32E (DIN69893-5)

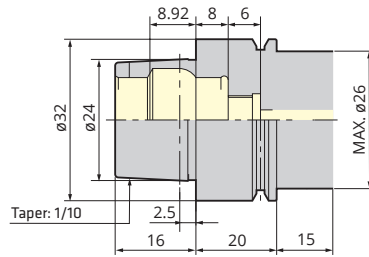

HSK40E (DIN69893-5)

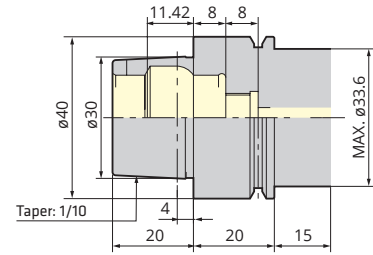

HSK40A (ISO 12164-1)

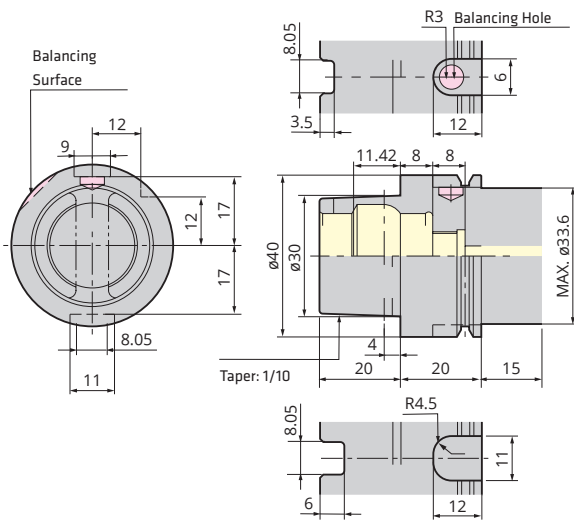

HSK63A (ISO 12164-1)

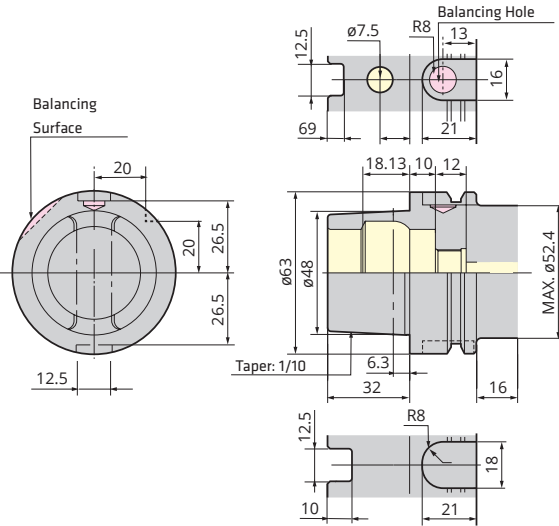

HSK100A (ISO 12164-1)

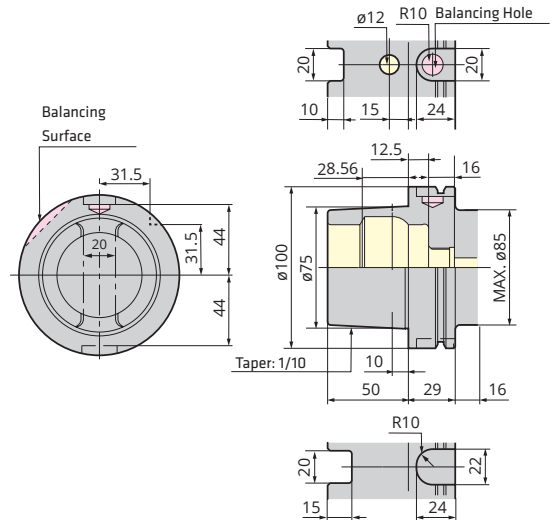

IT40 (ISO7388, DIN69871-'85)

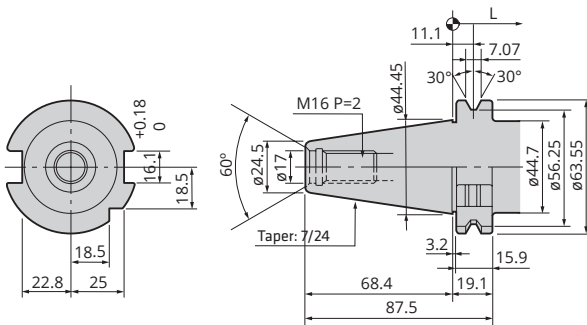

IT50 (ISO7388, DIN69871-'85)

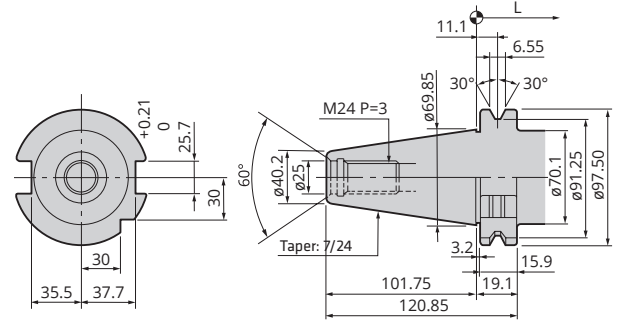

BT30

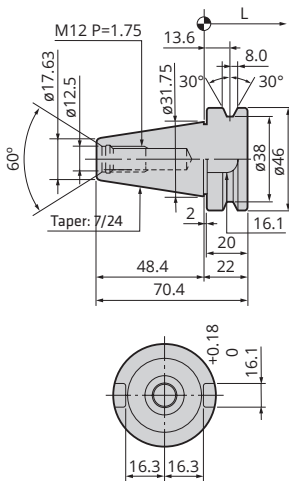

BT40

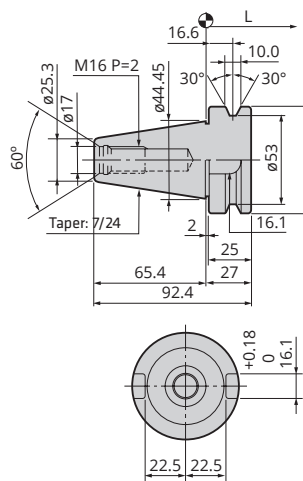

BT50

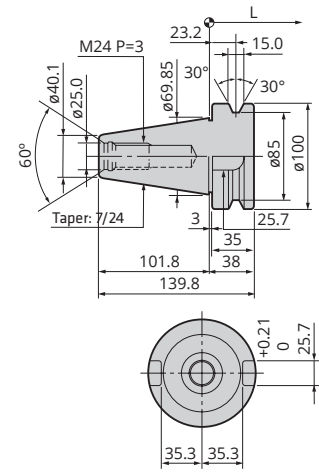

## SST / Nikken

### List of designations

ISO Attribute	Feature Designation	Note
ADJLXRDL	Radial Adjustment Range	
BD	Body Diameter	
BD1	Body Diameter	1 is Subscript
BD2	Body Diameter	2 is Subscript
DC	Diameter Range	
DCONMS	Mounting Diameter Machine Side	MS is Subscript
Diameter	Clamping Diameter, Nominal, Workpiece Side	WS is Subscript
DRVS	Width Across Flats	
LB1	Base Body Length	1 is Subscript
LB1	Base Body Length	1 is Subscript
LB2	Base Body Length	2 is Subscript
L	Cutting Edge Length	
LF	Function Length	
LSCN	Insertion Length min.	
LSCX	Insertion Length max.	
LU	Usable Length	
OAL	Total Length	
WF	Range of Functions	
LS	Shaft Length	











---

**NIKKEN KOSAKUSHO EUROPE LTD**

NIKKEN Innovation Centre Europe

Brindley Way, Catcliffe

Rotherham, S60 5FS

T: +44 (0) 1709 366 306

E [info@nikken-world.com](mailto:info@nikken-world.com)

W: [nikken-world.co.uk](http://nikken-world.co.uk)

---